

PCMCIA TYPE II

COMpad-32/85B

2 Port / 4 Port Interface Card

INSTALLATION GUIDE

CONTENTS

INSTALLATION

2 PORT COMPAD-32/85B.....	1
WINDOWS 95/98 INSTALLATION.....	1
WINDOWS NT INSTALLATION.....	4
DOS INSTALLATION.....	7
4 PORT COMPAD-32/85B.....	9
WINDOWS 95/98 INSTALLATION.....	9
WINDOWS NT INSTALLATION.....	12
DOS INSTALLATION.....	15
PC-COMLIB.....	17
PC-COMLIB INSTALLATION.....	17
PC-COMLIB QUICK REFERENCE (IN C).....	18

WINDOWS 95/98 INSTALLATION

RUNNING COMPAD-32/85B-2 UNDER WINDOWS 95/98

The COMpad-32/85B-2 card have separated driver for Windows 95.
The file name is A:\COMpad2\COMpad2.INF.

INSTALLATION

To install the COMpad-32/85B-2 Windows 95 driver, please follow the procedure as below:

1. Turn on your computer, run Windows 95.
2. Insert the COMpad-32/85B-2 into any of the empty PCMCIA type II slot.
3. The following message will display after you insert into the PCMCIA slot.
4. Select "Driver from disk provided by Hardware manufacture" then click OK.



5. The following message will display.

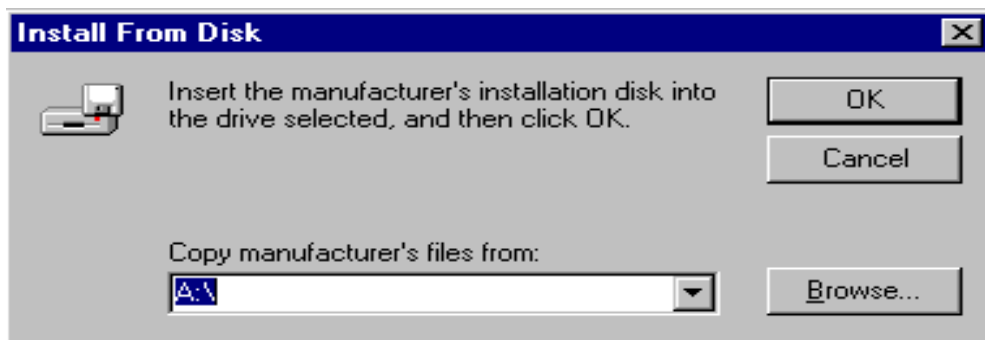

6. Insert the installation disk and click Browse. Select **A:\COMpad2\compad2.inf** and you have finished the installation procedure.

CHECK THE COMPAD-32/85B-2 IN WINDOWS 95'S CONFIGURATION

The Windows 95 has Plug & Play function, it manages the play-in card and other system automatically. If your COMpad-32/85B-2 PCMCIA card already install successfully, please follow the next step to check your COMpad-32/85B-2 Configuration in your system.

1. Double click the button of your mouse on “My Computer” icon.
2. Select the “System Properties”
3. Select the “ Device Manager”
4. Select “ View devices by connection”
5. Double click the “Cirrus Logic PCIC compatible PCI to PCMCIA bridge ”

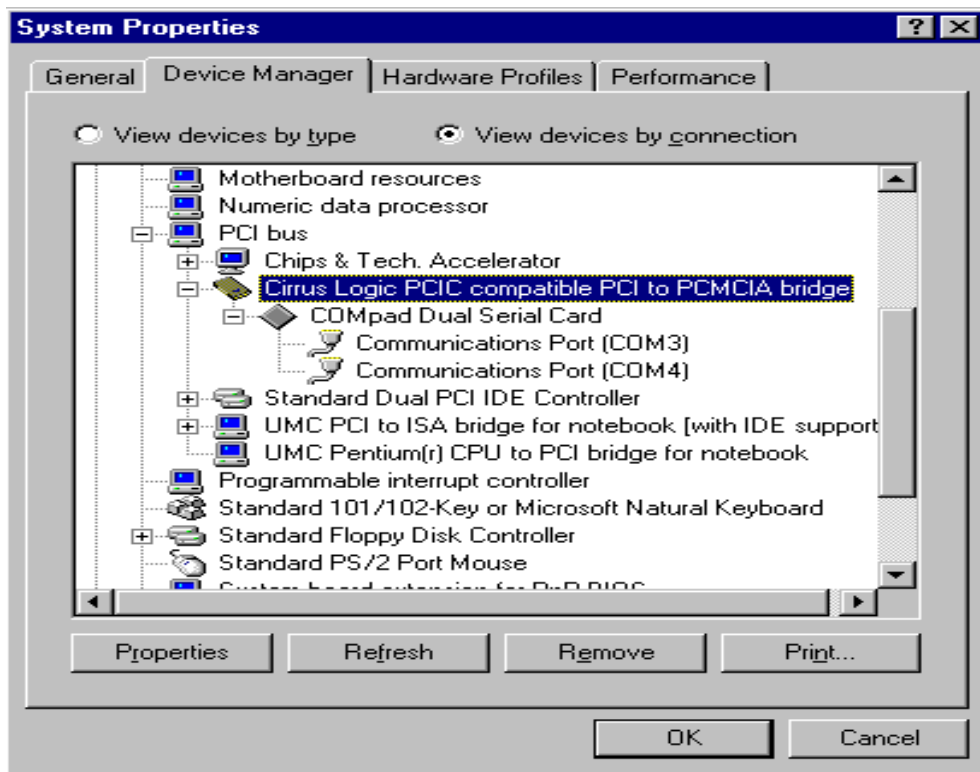

6. After the “COMpad Dual Serial Card” icon show-up on the screen.
7. The “Communication Port (COM X COM Y) will display. Now, in your computer system, Windows 95 operation system automatic configure your COMpad 32/85B -2 into the X and Y port (depend your system).

8. You can also check the I/O port address and IRQ of COMpad-32/85B-2 by double click the PCMCIA icon.
9. Double click the COMpad-32/85B-2 icon and select the "Resources", the COMpad-32/85B-2 resource type and setting automatically display.

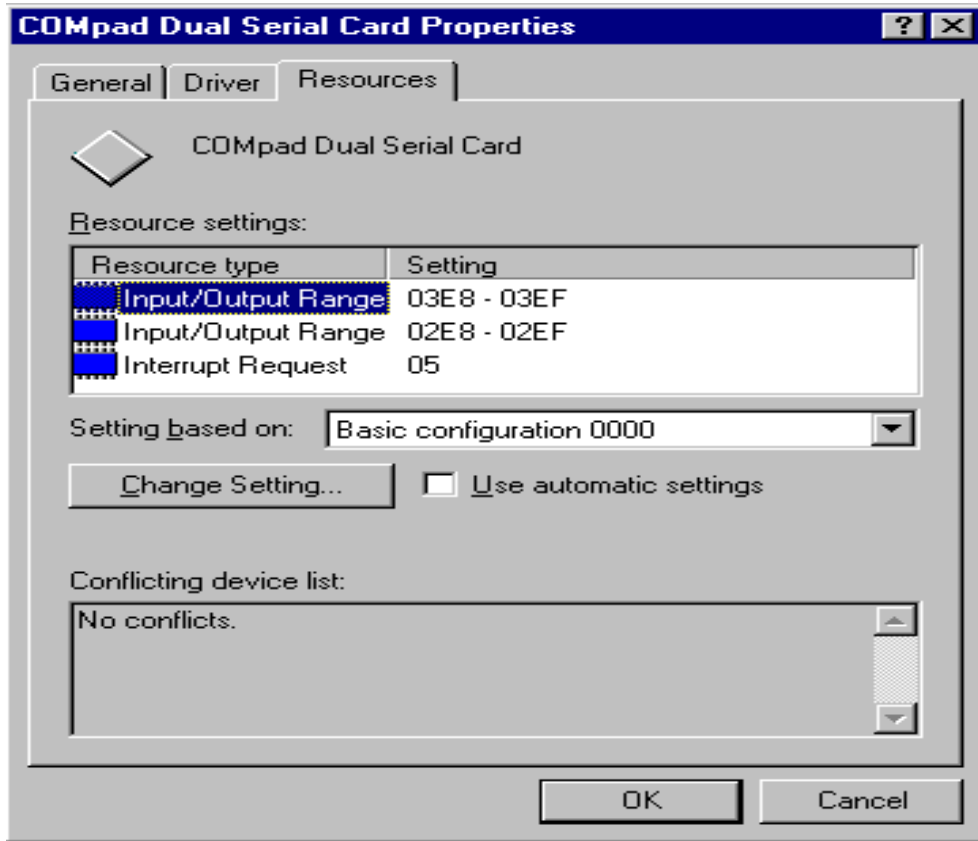

WINDOWS NT INSTALLATION

RUNNING COMPAD-32/85B-2 UNDER WINDOWS NT

The COMpad-32/85B-2 PCMCIA card has separated driver for Windows NT. The file name is A:\COMpad2\Winnt\setup.exe

Installation of COMpad 32/85B -2:

1. Insert the COMpad-32/85B-2 into any of the empty PCMCIA type II slot.
2. Select **A:\COMpad2\Winnt\SETUP.EXE** and follow its default steps.
3. After setup complete, if choose Yes, I want to restart my computer now, the system will use the default COM ports settings after system restart. If choose No, I will restart my computer later, the COM ports will not work properly until you plug in the card and restart.
4. For adjust the COM ports settings, you can “ **Run the Serial PC Card (2P) Settings**” icon by double click it in the Program Folder (or in the Control Panel) to adjust the COM port settings. The default COM ports set will be COM3 and COM4, I/O ports will be 3e8H and 2e8H, the IRQ will be 5.

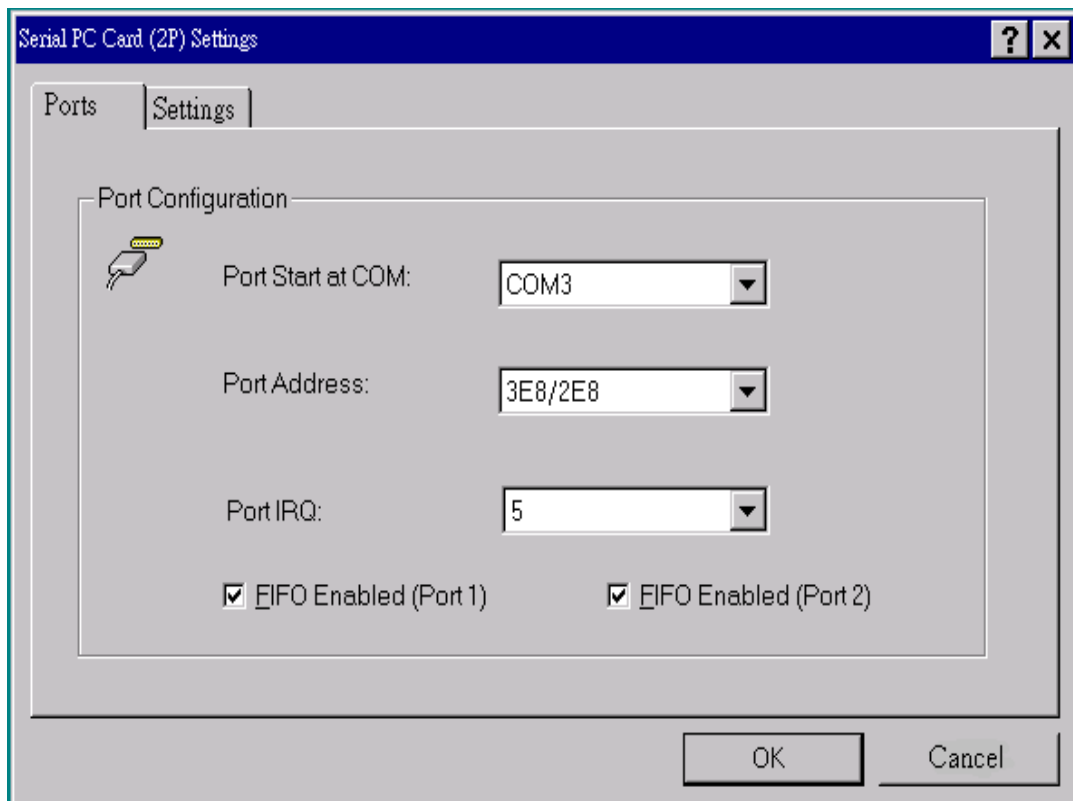

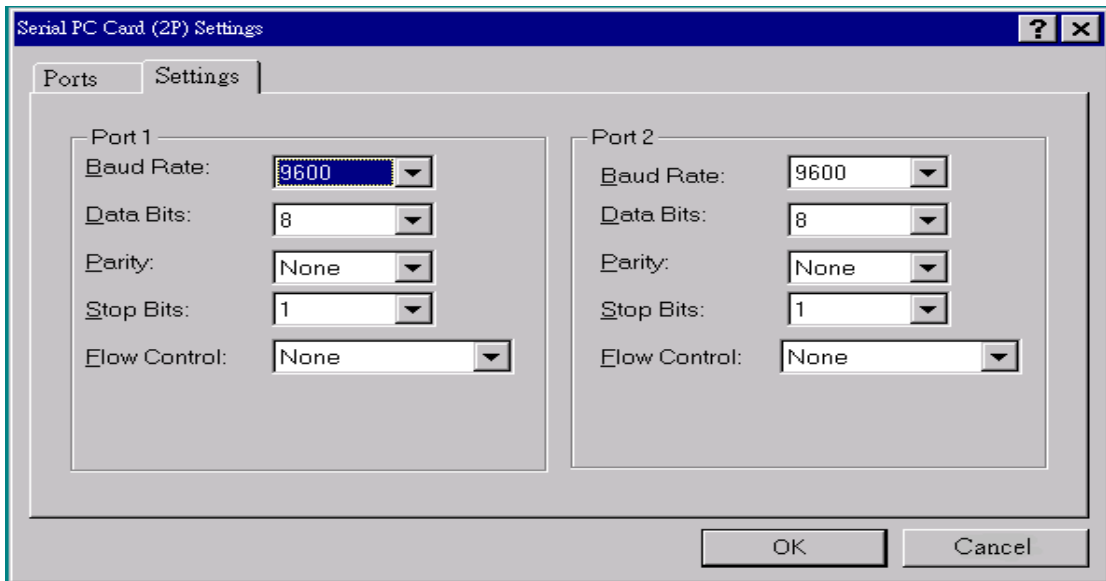

5. For check the system resources, run procedures below.

I. Start => Programs => Administrative Tools (Common) => **Windows NT Diagnostics**

Choose "**Resources**" to check the resources in your system to prevent from conflicts.

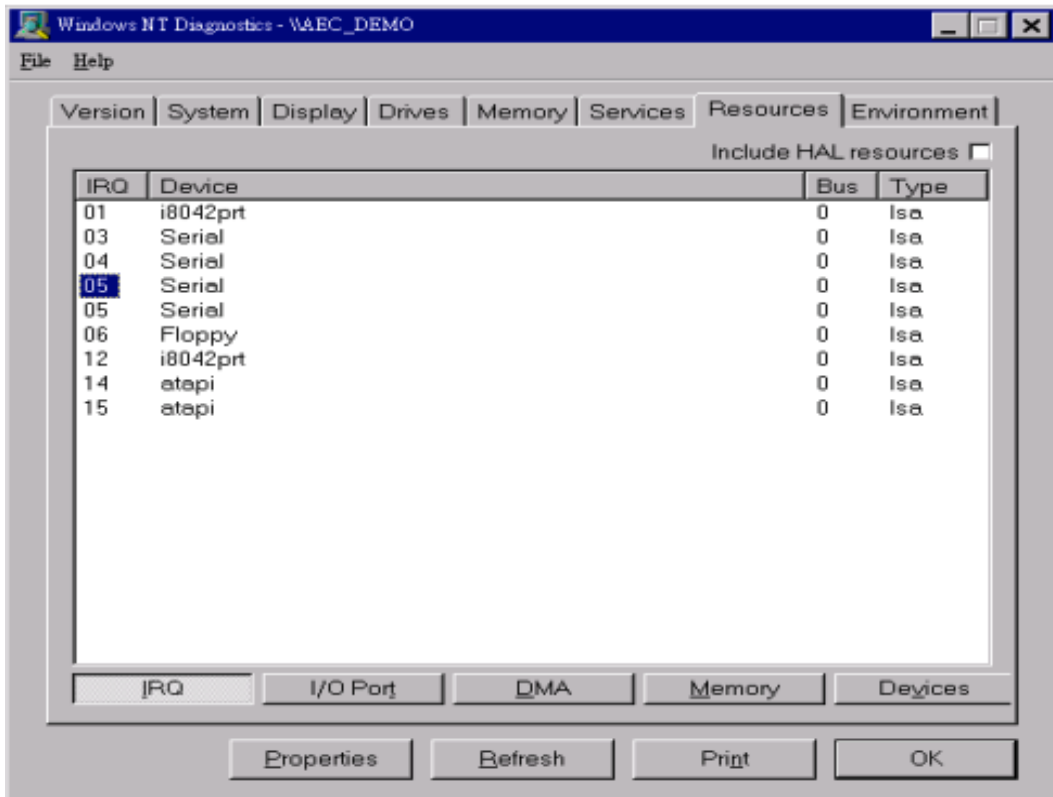

II. Device ==> Serial==> Properties.

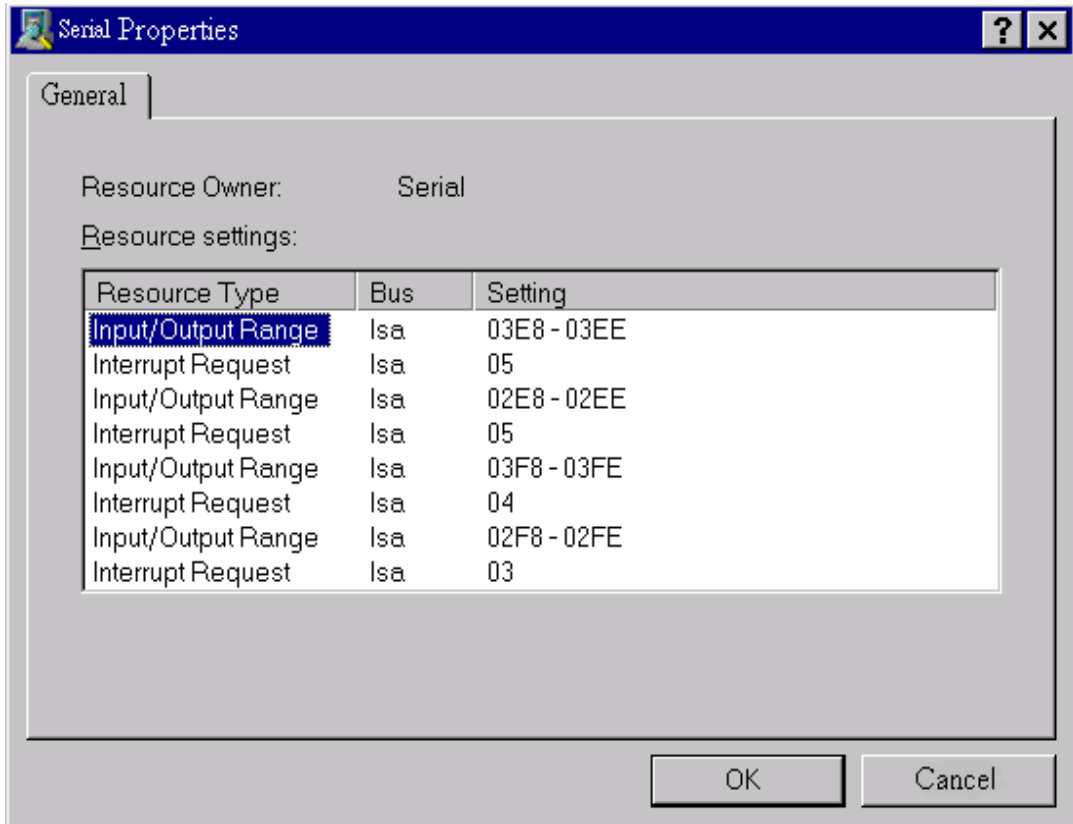

6.All settings will work properly after the system restart.

7.This version of Software will support NT Card Wizard plug and play function. Make sure to plug in the card during the system boot up time, the plug and play function will then work properly.

DOS INSTALLATION

2 Port COMpad-32/85-2 card installation:

The following description provides you with a general procedure how to install the COMpad-32/85B-2 into the majority of notebook computers on the market today.

1. Turn-off the notebook computer power, and locate the notebook's PCMCIA slot. Although PCMCIA systems allow "hot insertion", installing of the card while the computer is running. But not every Notebook computer was implement this feature, check the user's manual for your notebook. If you are in doubt, turn the power off first.
2. Align the COMpad-32/85B-2 card with the arrow facing up and pointing towards the computer's PCMCIA slot.
3. Slowly insert the card in the slot. After the card slides in, press it firmly until the connector is seated.
4. Attach the COMpad-32/85B-2 terminal board connector to the rear end of the PCMCIA card.

2 Port COMpad-32/85B-2 Driver installation and configuration:

Most notebook computer suppliers provide a PCMCIA device driver to operate the PCMCIA slot. However we strongly recommend that you install the special COMpad-32/85B-2 driver. The COMpad-32/85B-2's device driver only support INTEL 82365 or compatible PCMCIA control chip (Cirrus logic PD6720, Vadem VG365 etc.). If your computer doesn't use the INTEL 82365 or compatible PCMCIA contrl chip, you have to install PCMCIA software(Cardsoft, Cardtalk etc.) for using the COMpad-32/85B-2. However if you use PCMCIA software make sure you install the PCMCIA software already before install the COMpad-32/85B-2 device driver.

Do the following steps to install the special driver.

1. Insert the COMpad-32/85B device driver diskette into a floppy drive.
2. At the DOS prompt (A:\COMPAD2\DOS> or B:\COMPAD2\DOS>) type **INSTALL** and press the ENTER key.
3. Set the File path, Base Address and IRQ channel number.
4. After you enter the settings, the setup program detects the type of PCMCIA interface then copies files to harddisk driver and inserts the COMpad-32/85B-2 device driver to CONFIG.SYS file.

The install program will add the following line to your config.sys:

```
DEVICE=C:\COMPAD\COMPAD2.EXE /Ax /Qy
```

where:

x represents the base address. Valid options are:

x = 1:	COM3/COM4(3E8h/2E8h)	x = 2:	330h ~ 33Fh
x = 3:	340h ~ 34Fh	x = 4:	350h ~ 35Fh
x = 5:	360h ~ 36Fh		

y represents the IRQ channel number. Valid options are:

y = 3: IRQ3

y = 5: IRQ5

y = 9: IRQ9

y = 4: IRQ4

y = 7: IRQ7

y = 12: IRQ12

In order for COMpad-32/85B-2 device driver to function properly, you have to reserve 4K memory space for each PCMCIA card in your system. For example: If you use EMM386 memory manage software, please edit the line in your Config.sys file to appear below:

```
DEVICE=C:\DOS\EMM386.EXE X=D000-DFFF
```

After COMpad-32/85B-2 device driver install finished, you have to re-boot your computer. If the COMpad-32/85B-2 is present, the device driver will show a message like one below:

```
Configure card to:           I/O prot   : 2E8-2EF, 3E8-3EF
                           IRQ number: 5
                           Power      : connected
```

COMpad card is present in socket 1

Otherwise the device driver will show a message like one below:

COMpad card is not present

The COMpad-32/85B Pin Assignment

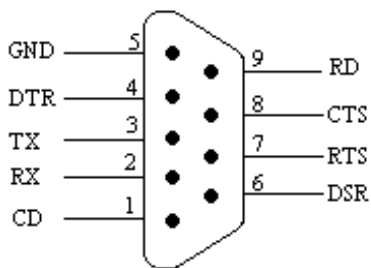

COMpad-32B

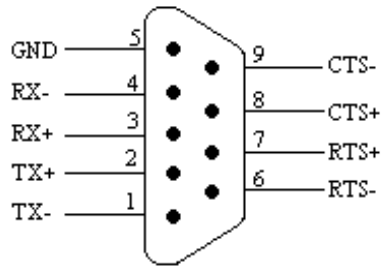

COMpad-85B

WINDOWS 95/98 INSTALLATION

RUNNING COMPAD-32/85B-4 UNDER WINDOWS 95

The COMPAD-32/85B-4 card have separated driver for Windows 95.
The file name is A:\COMpad4\COMPAD4.INF.

INSTALLATION

To install the COMpad-32/85B-4 Windows 95 driver, please follow the procedure as below:

1. Turn on your computer, run Windows 95.
2. Insert the COMpad-32/85B-4 into any of the empty PCMCIA type II slot.
3. The following message will display after you insert into the PCMCIA slot.
4. Select "Driver from disk provided by Hardware manufacture" then click OK.

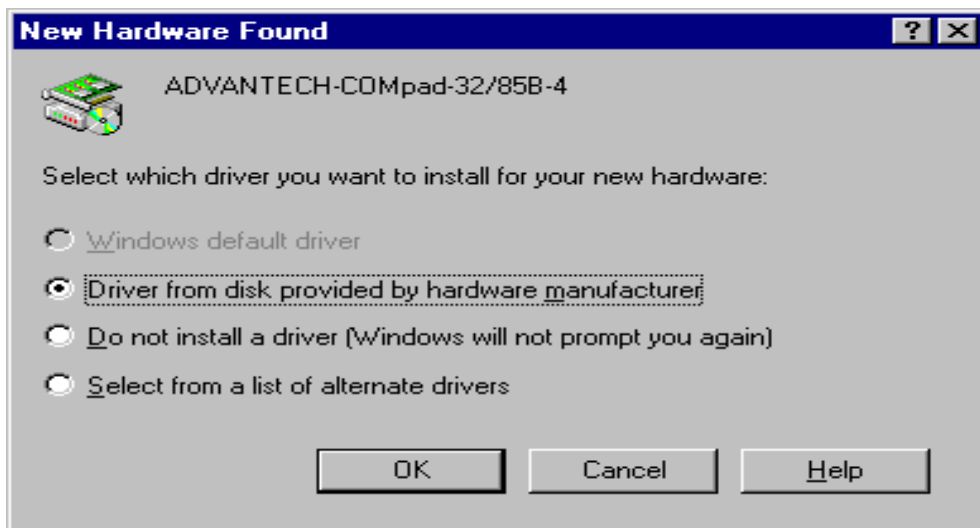

5. The following message will display.

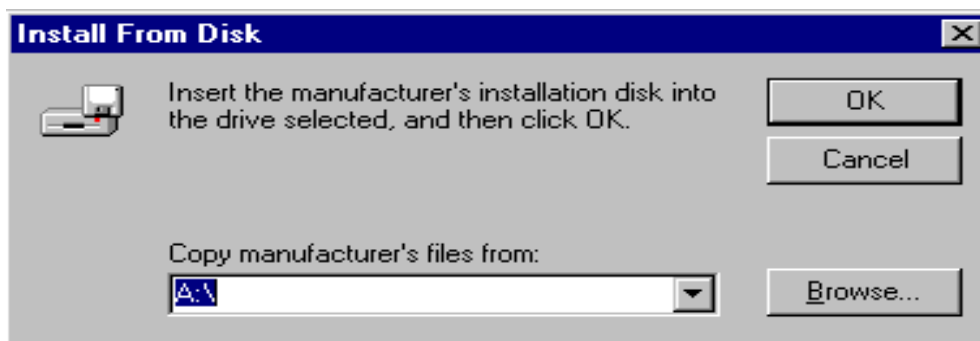

6. Insert the installation disk and click Browse. Select A:\COMpad4\compad4.inf and you have finished the installation procedure.

CHECK THE COMPAD-32/85B-4 IN WINDOWS 95'S CONFIGURATION

The Windows 95 has Plug & Play function, it manages the play-in card and other system automatically. If your COMpad-32/85B-4 PCMCIA card already install successfully, please follow the next step to check your COMpad-32/85B-4 Configuration in your system.

1. Double click the button of your mouse on “My Computer” icon.
2. Select the “System Properties”
3. Select the “ Device Manager”
4. Select “ View devices by connection”
5. Double click the “Cirrus Logic PCIC compatible PCI to PCMCIA bridge ”

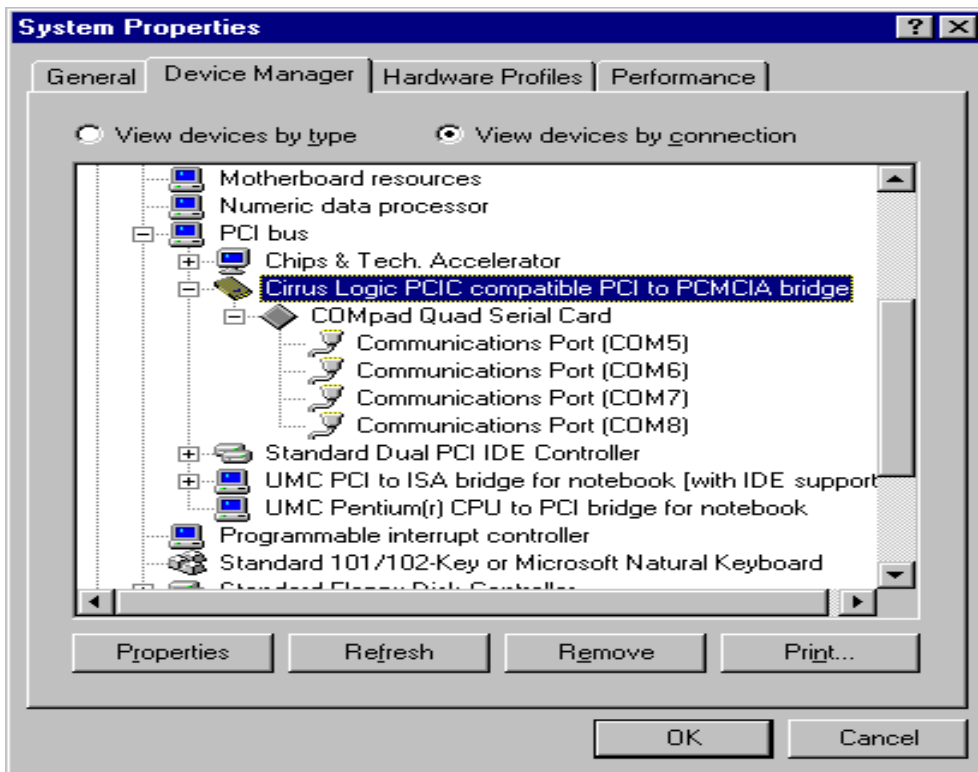

6. After the “COMpad Quad Serial Card” icon show-up on the screen, and click the “COMpad Quad Serial Card” icon.
7. The “Communication Port (COM w COM x COM y COM z)” will display. Now, in your computer system, Windows 95 operation system automatic configure your COMpad-32/85B-4 into the w, x, y, and z port (depend your system).

8. You can also check the I/O port address and IRQ of COMpad-32/85B-4 by double click the PCMCIA icon.
9. Double click the COMpad-32/85B-4 icon and select the "Resources", the COMpad-32/85B-4 resource type and setting automatically display.

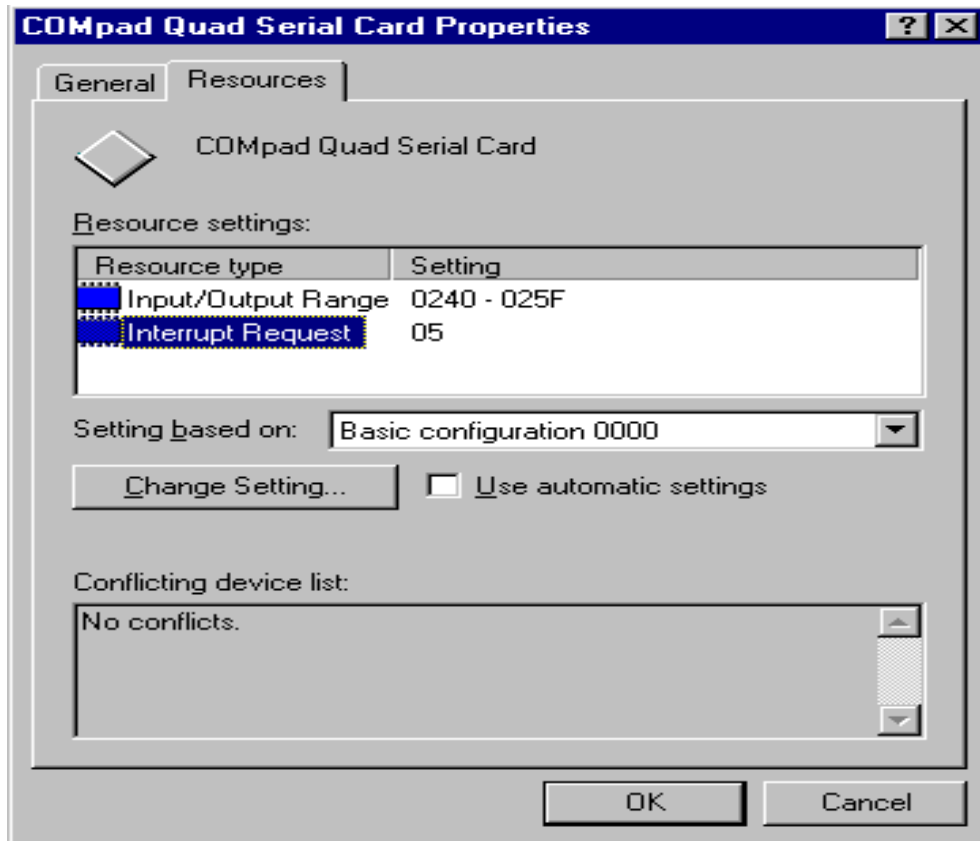

WINDOWS NT INSTALLATION

RUNNING COMPAD-32/85B-4 UNDER WINDOWS NT

The COMpad-32/85B-4 PCMCIA card has separated driver for Windows NT.
The file name is A:\COMpad4\Winnt\setup.exe

Installation of COMpad-32/85B-4:

1. Insert the COMpad-32/85B-4 into any of the empty PCMCIA type II slot
2. Select **A:\COMpad4\Winnt\SETUP.EXE** and follow its default steps.
3. After setup complete, if choose Yes, I want to restart my computer now, the system will use the default COM ports settings after system restart. If choose No, I will restart my computer later, the COM ports will not work properly until you plug in the card and restart.
4. For adjust the COM ports settings, you can run the **Serial PC Card (4P) Settings** icon by double click it in the Program Folder to adjust the COM port settings. The default COM ports set will be COM5 to COM8, I/O ports will be 240H to 25FH, the IRQ will be 5.

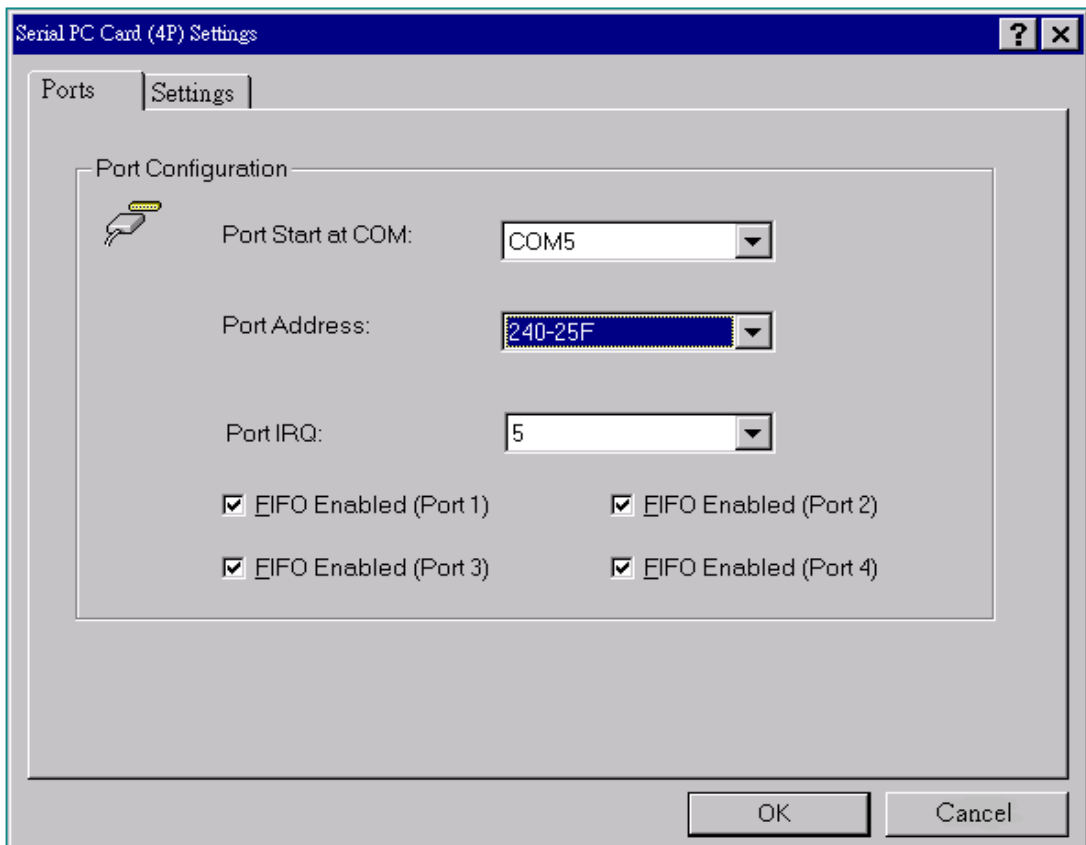

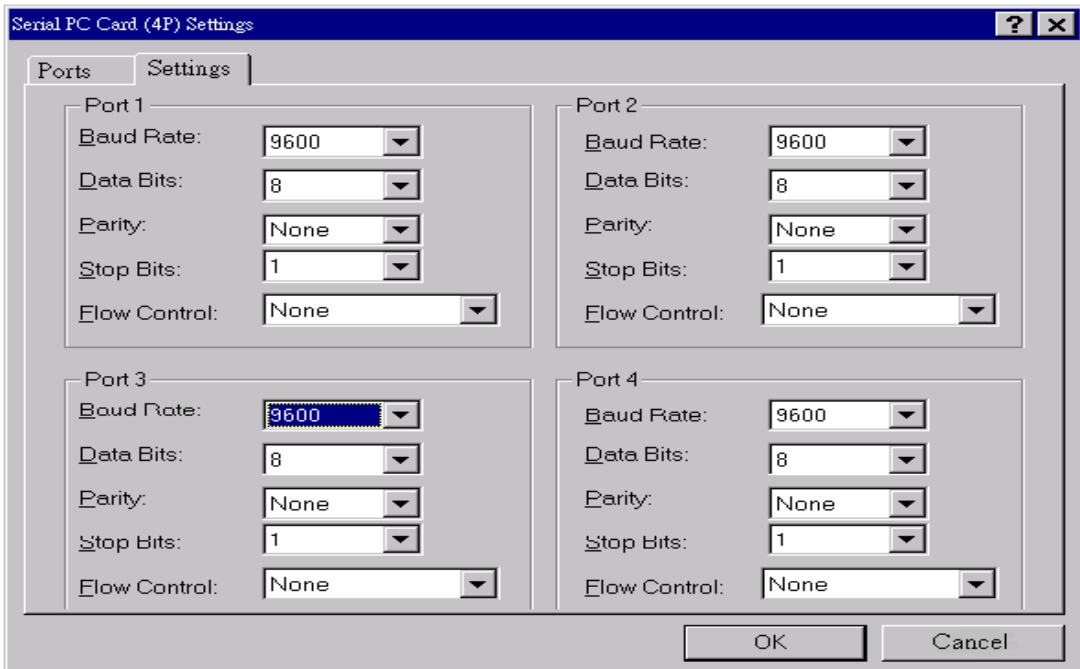

5. For check the system resources, Run procedures below.

I.Start => Programs => Administrative Tools (Common) => **Windows NT Diagnostics**

Choose "**Resources**" to check the resources in your system to prevent from conflicts.

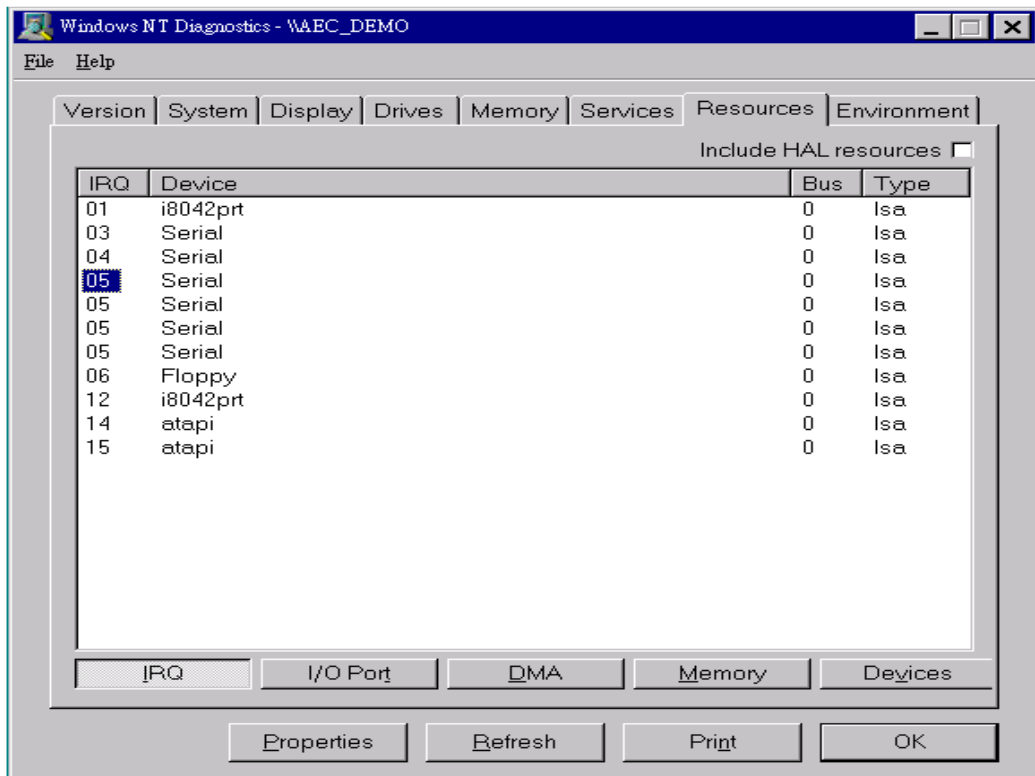

II. Device ==> Serial==> Properties.

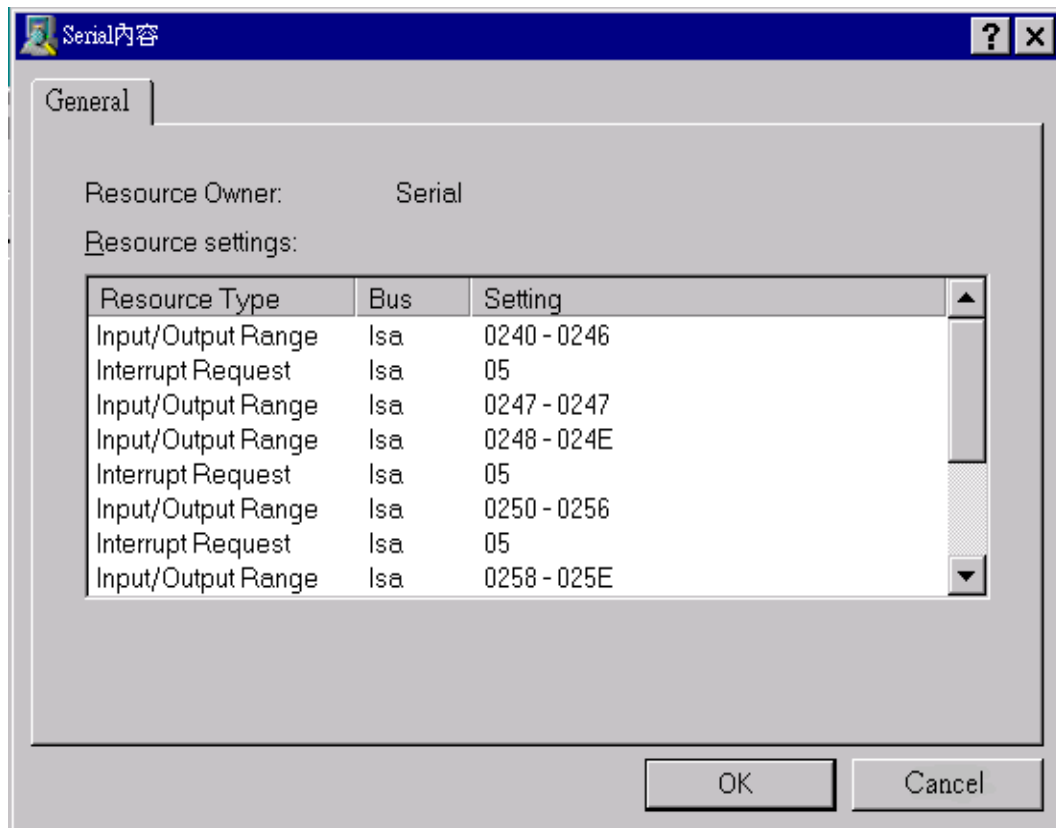

6.All settings will work properly after the system restart.

7.This version of Software will support NT Card Wizard plug and play function. Make sure to plug in the card during the system boot up time, the plug and play function will then work properly.

8.This version of Hardware will install four COM ports in the system and work simultaneously sharing the same IRQ.

DOS INSTALLATION

4 Port COMpad-32/85-4 card installation:

The following description provides you with a general procedure how to install the COMpad-32/85B-4 into the majority of notebook computers on the market today.

1. Turn-off the notebook computer power, and locate the notebook's PCMCIA slot. Although PCMCIA systems allow "hot insertion", installing of the card while the computer is running. But not every Notebook computer was implement this feature, check the user's manual for your notebook. If you are in doubt, turn the power off first.
2. Align the COMpad-32/85B-4 card with the arrow facing up and pointing towards the computer's PCMCIA slot.
3. Slowly insert the card in the slot. After the card slides in, press it firmly until the connector is seated.
4. Attach the COMpad-32/85B-4 terminal board connector to the rear end of the PCMCIA card.

4 Port COMpad-32/85B-4 Driver installation and configuration:

Most notebook computer suppliers provide a PCMCIA device driver to operate the PCMCIA slot. However we strongly recommend that you install the special COMpad-32/85B-4 driver. The COMpad-32/85B-4's device driver only support INTEL 82365 or compatible PCMCIA control chip (Cirrus logic PD6720, Vadem VG365 etc.). If your computer doesn't use the INTEL 82365 or compatible PCMCIA contrl chip, you have to install PCMCIA software(Cardsoft, Cardtalk etc.) for using the COMpad-32/85B-4. However if you use PCMCIA software make sure you install the PCMCIA software already before install the COMpad-32/85B-4 device driver.

Do the following steps to install the special driver.

1. Insert the COMpad-32/85B device driver diskette into a floppy drive.
2. At the DOS prompt (A:\COMPAD4\DOS> or B:\COMPAD4\DOS>) type **INSTALL** and press the ENTER key.
3. Set the File path, Base Address and IRQ channel number.
4. After you enter the settings, the setup program detects the type of PCMCIA interface then copies files to harddisk driver and inserts the COMpad-32/85B-4 device driver to CONFIG.SYS file.

The install program will add the following line to your config.sys:

```
DEVICE=C:\COMPAD\COMPAD4.EXE /Ax /Qy
```

where:

x represents the base address. Valid options are:

x = 1: COM5/COM6/COM7/COM8(240h/248h/250h/258h)

x = 2: 340h ~ 35Fh

y represents the IRQ channel number. Valid options are:

y = 3: IRQ3	y = 4: IRQ4
y = 5: IRQ5	y = 7: IRQ7
y = 9: IRQ9	y = 12: IRQ12

In order for COMpad-32/85B-2 device driver to function properly, you have to reserve 4K memory space for each PCMCIA card in your system. For example: If you use EMM386 memory manage software, please edit the line in your Config.sys file to appear bellow:

```
DEVICE=C:\DOS\EMM386.EXE X=D000-DFFF
```

After COMpad-32/85B-2 device driver install finished, you have to re-boot your computer. If the COMpad-32/85B-2 is present, the device driver will show a message like one below:

```
Configure card to:      I/O prot   : 240-246,248-24F,250-257,258-25F
                       IRQ number: 5
                       Power      : connected
```

COMpad card is present in socket 1

Otherwise the device driver will show a message like one below:

COMpad card is not present

The COMpad-32/85B Pin Assignment

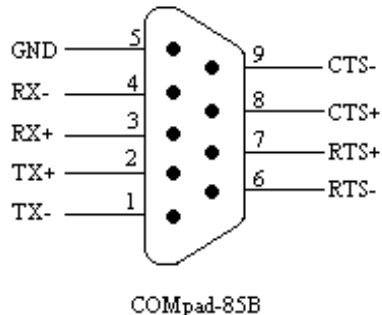
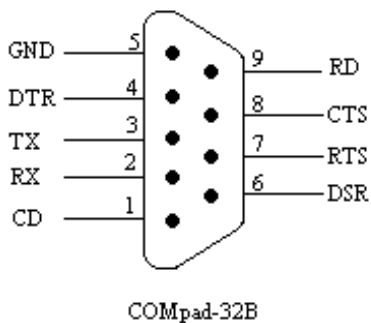

PC-COMLIB INSTALLATION

PC-ComLIB software Installation

Copy the file in the **A:\COMpad2\Pc-com.exe** or **A:\COMpad4\Pc-com.exe** to your hard disk. Run this file, and it will create a directory on your hard disk. The name of directory is **PC-COM.LIB**

PC-ComLIB software configuration

The SETUP.exe program is used to define it must be executed before running any user applications, terminal emulation, or DataScope programs, even if you are using only standard-equipment COM ports. Since the driver is a TSR type program, it is NOT necessary to execute it during boot-up. To run the standard COM1/COM2 port driver, go to GEN-DRV. After a while, the screen will show:

PC-ComLIB Communication Driver (Ver x.xx)

General Serial I/O card : 2 Ports

DEVICE DRIVER SETUP O.K.

The driver will detect I/O card automatically. If the card does not match the setup data, the screen will show a message like following:

Serial I/O card Not Found

Now you can execute DataScope or your own application program with the PC-ComLIB library. To execute DataScope, enter SCOPE at DOS the prompt.

To remove a driver from memory, user only execute the GEN-DRV with a /Q switch, i.e., GEN-DRV/Q. The screen will then display:

PC-ComLIB Communication Driver (Ver. x.xx) Release O.K.

Executing an application program after the driver has been removed may cause an error. You can reinstall the driver at any time. For more detailed information about PC-ComLIB operating and programming please refer to file COMLIB.DOC.

PC-COMLIB QUICK REFERENCE (IN C)

1. Syntax `int sio_reset()`

Reset all serial port, disable all interrupt service routines and flush Tx/Rx buffer.

2. Syntax `int sio_getpors(int *port_no_array,int array_size)`

Get the total serial ports no. and the individual port number which are saved in `port_no_array[]`.

3. Syntax `int sio_loopback(int port, char *buf, int len)`

Serial port loop back mode transmit/receive test.

[Note]: After loopback testing, this port will be reset and closed.

4. Syntax `int sio_open(int port)`

Open Serial Port.

5. Syntax `int sio_close(int port)`

Close Serial Port.

6. Syntax `int sio_ioctl(int port,int baud, int mode)`

Serial port IOCTL setting.

7. Syntax `int sio_getch(int port)`

Get One Character From Rx Buffer.

8. Syntax `int sio_linput(int port, char *buf, int len, int term)`

Read Back The Data String Until The Terminator Character.

9. Syntax `int sio_read(int port, char *buf, int len)`

Read Some Length Data

10. Syntax `int sio_putch(int port, int code)`

Put a Character to Tx Buffer

11. Syntax `int sio_putb(int port, char *buf, int len)`

Put a Block Character Data to Tx Buffer, If the Tx buffer free space is smaller than block length, it will return zero.

12. Syntax `int sio_write(int port, char *buf, int len)`

Write a String Data to Tx Buffer

13.Syntax int sio_flush(int port, int func)

Flush Tx/Rx Buffer Data

14.Syntax long sio_iqueue(int port)

Read the data length which queued in Rx buffer.

15.Syntax long sio_ifree(int port)

Read the free space of Rx buffer

16.Syntax long sio_oqueue(int port)

Read the data length which queued in Tx buffer.

17.Syntax long sio_ofree(int port)

Read the free space of Tx buffer.

18.Syntax int sio_lstatus(int port)

Get Modem Line Status.

19.Syntax int _lctrl(int port, int mode)

Setting Modem Line Control.

20.Syntax int sio_term_irq(int port, interrupt (*func)(), char code)

Setting Terminator Code Interrupt Service Routine.

21.Syntax int sio_break_irq(int port, interrupt (*func)())

Setting Break Detect Interrupt Service Routine.

22.Syntax int sio_modem_irq(int port, interrupt (*func)())

Setting Modem Status Change Interrupt Service Routine.

23.Syntax int sio_cnt_irq(int port, interrupt (*func)(), int count)

Setting Data Count Interrupt Service Routine.

24.Syntax int sio_break(int port, int time)

Send Out Break Counter.

25.Syntax int sio_brk_cnt(int port)

Get and Clear Break Counter.

26.Syntax int sio_flowctrl(int port, int mode)

Setting CTS/RTS/XON/XOFF Flow Control.

27.Syntax int sio_Tx_hold(int port)

Is Transmit Interrupt Hold by CTS low?

28.Syntax int sio_disableTx(int port)

Disable Transmit Interrupt.

29.Syntax int sio_enable(int port)

Enable Transmit Interrupt.

30.Syntax int sio_getbaud(int port)

Get Serial Port baud rate setting.

31.Syntax int sio_getmode(int port)

Get the Serial Port mode setting.

32.Syntax sio_getflow(int port)

Get the Serial Port CTS/RTS/XON/XOFF flow control setting.

33.Syntax int sio_timeout(time_tic)

Set the sio_linput_t() and sio_putb_t() time out tic.

34.Syntax int sio_linput_t(int port, char *buf, int len, int term)

Read Back The Data String Until The Terminator Character, with time out check.

35.Syntax int sio_putb_t(int port, char *buf, int len)

Put a Block Character Data to Tx Buffer, with time out check.

36.Syntax int sio_overflow(int port)

Get the Serial Port received buffer data overflow status.

37.Syntax int sio_overlap(int port,int mode)

Set the Serial Port received data overlap function when buffer full.