

DL-100S-E/DL-101S-E DL-110-E/DL-120-E

Illumination/Temperature/Humidity/Dew Point

Data Logger User Manual



Version: 1.0.0
Date: May 2020

Warranty

All products manufactured by ICP DAS are warranted against defective materials for a period of one year from the date of delivery to the original purchaser.

Warning

ICP DAS assumes no liability for damages consequent to the use of this product. ICP DAS reserves the right to change this manual at any time without notice. The information furnished by ICP DAS is believed to be accurate and reliable. However, no responsibility is assumed by ICP DAS for its use, nor for any infringements of patents or other rights of third parties resulting from its use.

Copyright

Copyright © 2018 by ICP DAS. All rights are reserved.

Contact Us

If you have any questions, feel free to contact us via email at:

Service@icpdas.com

Contents

1. Introduction	1
2. Hardware	4
2.1 Specifications	4
2.2 Appearance.....	6
2.3 Dimensions (unit: mm)	14
2.4 Cabling for Power and Network	15
3. Configuration via Web Browser.....	17
3.1 Search the DL-100S-E series module logger.....	17
3.2 Logging into the DL-100S-E.....	18
3.3 Home	19
3.4 Network.....	20
3.5 MQTT.....	22
3.6 I/O Settings	25
3.7 Filter IP	29
3.8 Monitor.....	30
3.9 Change Password.....	30
3.10 Logout.....	31
4. Configuration via RS-485(DL-110-E / DL-120-E Only).....	32
4.1. Building the RS-485 Connection.....	32
4.2. AI tab.....	36
4.3 Logger Configuration	37
5. Monitoring via Mobile Devices	38
6. Utility to Get/Manage Data Log	39
7. FAQ.....	50
Q1: How to set the Accessible IP?	50
Q2: How to delete the Accessible IP settings?.....	50
Q3: How to clear the data logged in a DL-100S-E module?.....	51
Q4: How to download firmware into a DL-101S-E module?.....	51
Appendix A: ModbusMasterToolPC.....	55
Appendix B: Modbus Address Table.....	58
B-1. DL-100S-E Modbus Address Mappings (Base 1)	58
B-2. DL-101S-E Modbus Address Mappings (Base 1)	61
B-3. DL-110-E Modbus Address Mappings (Base 1).....	65
B-4. DL-120-E Modbus Address Mappings (Base 1)	69
Revision History	72

1. Introduction

The DL-100S-E series are Data Logger devices that can be used to record illumination, temperature, humidity and dew point data, together with date and time stamp information. Up to 600,000 downloadable records can be stored. Real-time data can be accessed from the DL-100S-E series device from anywhere and at any time using the free Windows software, the iOS App or the Android App, as long as they are connected to the same local network as the Data Logger. The DL-100S-E series module supports popular industrial protocols such as Modbus TCP, as well as the emerging machine-to-machine (M2M)/IoT (Internet of Things) connectivity protocol – MQTT. The DL-100S-E Series Data Logger can be connected using a variety of communication interfaces, including Ethernet and PoE, meaning that the device can be easily integrated into existing HMI or SCADA systems, and are easy to maintain in a distributed control system.

Characteristics

- ▶ Illumination Measurement Range: 0 to 100,000 Lux (DL-110-E / DL-120-E Only)
- ▶ Temperature Measurement Ranges: -20 to +60°C and 0 to 100% RH
- ▶ LCD Display Shows Temperature, Humidity, Relative Humidity, Date and Time(DL-100S-E / DL-101S-E Only)
- ▶ Able to store up to 600,000 records with date and time stamps
- ▶ Free Software Utility, iOS APP and Android App Included
- ▶ Supports the Modbus TCP and MQTT protocols
- ▶ Includes redundant power inputs: PoE (IEEE 802.3af, Class 1) and DC input (DL-101S-E / DL-110-E / DL-120-E Only)
- ▶ Relay Output for Alarm Devices or IAQ Device Control (DL-101S-E Only)
- ▶ Supports Web Configuration and Firmware Update via Ethernet
- ▶ IP 66 Protection Approval (DL-100S-E / DL101S-E Only)
- ▶ IP 65 Protection Approval (DL-110-E / DL-120-E Only)
- ▶ DIN-Rail or Wall Mounted

Features

▶ Built-in Web Server

With the built-in Web server, users can easily log in to the DL-100S-E series module via a standard web browser to monitor the data and configure the settings without install any software in the terminal.

▶ Get Real-time Data Anywhere and Anytime

iAir App for iOS or Android Phones or Tablets is free and easy to install, it can obtain the real-time data from DL-100S-E series module over a Wi-Fi network anytime and anywhere. The iAir App can link to the DL-100S-E series modules by specifying IP addresses or by searching all the modules connected to the same Ethernet segment.



▶ Data Logging Software

The DL-300 Utility can be used to configure a module and monitor real-time data, as well as display the run chart, log alarm events, or group DL-100S-E series module so that the status of distribution groups can be viewed and managed. The utility also allows the log data to be downloaded and exported to a .CSV file that can then be imported into any industry-standard software or spreadsheet for analysis.

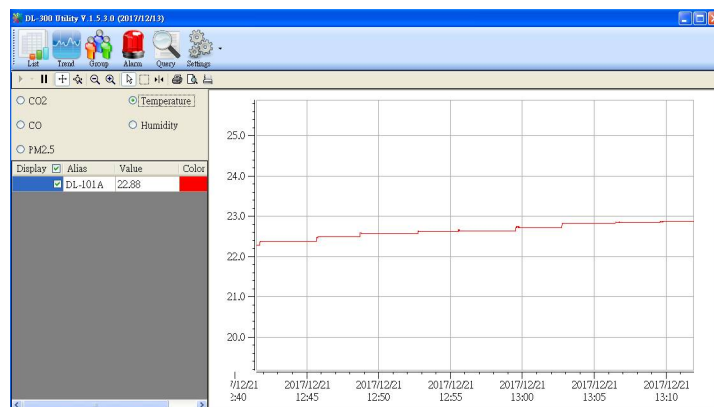

▶ **Easy integration with SCADA software**

Modbus is one of the most popular protocols used in the industrial world. Supporting traditional serial protocols of Ethernet protocols allow the DL-100S-E series module well-integrated into the HMI/SCADA systems.

▶ **Easy Wiring**

Support for Ethernet and Power over Ethernet (PoE) interfaces for users to choose the appropriate one to meet the field requirements.

▶ **Power over Ethernet (PoE)**

The DL-100S-E series module features true IEEE802.3af-compliant (classification, Class 1) PoE technology that allows both power and data to be carried over a single Ethernet cable. PoE provides a unified power system, as well as backup provisions for critical building functions, without any additional cables, outlets or connections. It can reduce the power supply wiring and maintenance costs, and improve system scalability.

▶ **Support for MQTT protocol**

MQTT is a protocol designed for the efficient exchange of real-time data with sensor and mobile devices. It runs over TCP/IP and is in widest use on the "machine-to-machine" (M2M) and "Internet of Things" applications today

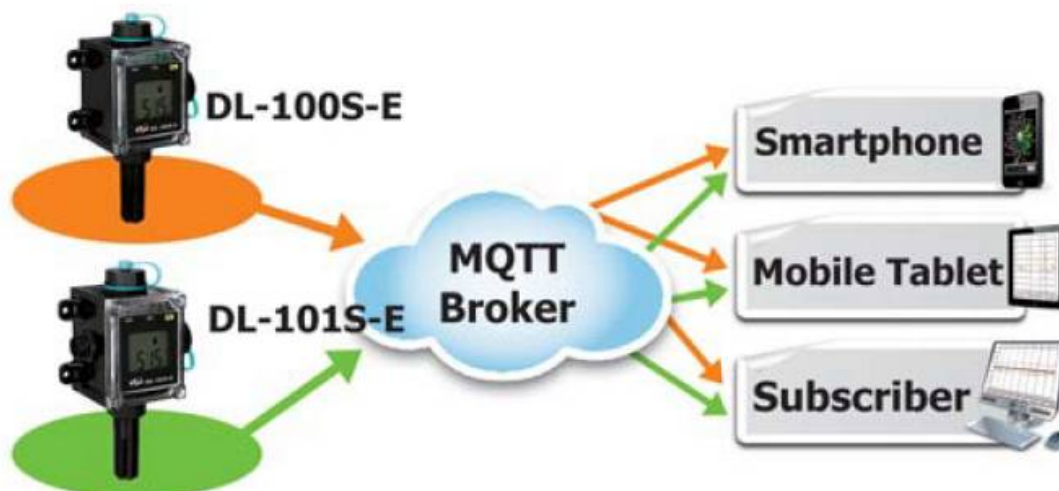

2. Hardware

2.1 Specifications

Model	DL-100S-E	DL-101S-E	DL-110-E	DL-120-E
Illumination Measurement				
Range	-		0 to 100,000 Lux	
Resolution	-		1 Lux	
Accuracy	-		±5%	
Response Time	-		1 second	
Temperature Measurement				
Range	-20 to +60°C (-31 to +176°F)			-
Resolution	0.1°C			-
Accuracy	Typical: ±0.4°C; refer to figure 2			-
Relative Humidity Measurement				
Range	0 to 100% RH			-
Resolution	0.1% RH			-
Accuracy	Typical: ±3% RH @ 20 ~ 80% RH; refer to figure 1			-
LCD LED Display				
LCD Information Displayed	Temperature (°C and °F), Humidity (RH), Relative,		-	
PWR	System indicator (Green)			
Link	Link/Act indicator (Green)			
PoE	PoE indicator (Red)			
Software				
Built-in Web Server	Yes			
Communication				
RS-485 Port	-	Baud Rate = 1200 ~ 115200 bps		
Ethernet Port	10/100 Base-TX with Auto MDI/MDI-X			
Protocol,	Modbus TCP and MQTT		DCON, Modbus RTU Modbus TCP and MQTT	
Security	Password and IP Filter			
Dual Watchdog	Yes, Module (2.3 seconds), Communication (Programmable)			
System				
Real Time Clock	Yes			
Data Logger	Yes, 600,000 Records			

PhotoMos Relay Output	-	Form A×2, SPST 100 VDC	-	
Interface	Ethernet/PoE		RS-485/Ethernet/PoE	
Electrical				
Powered via Terminal	-	+12 to +48 VDC		
Powered via PoE	IEEE 802.3af, Class 1 (require a PoE switch or injector)			
Power Consumption	PoE	0.7 W (Max.)	0.7 W (Max.)	1.2 W (Max.)
	Non-PoE	-	0.6 W (Max.)	1.1 W (Max.)
Mechanical				
Dimensions (W x L x H)	92 mm x 157 mm x 56 mm	100 mm x 157 mm x 56 mm	100 mm x 131 mm x 67 mm	100 mm x 117 mm x 67 mm
Waterproof Level	IP66		IP65	
Installation	DIN-Rail or Wall mounted			
Environment				
Operating Temperature	-20 to +60°C			
Storage Temperature	-30 to +80°C			
Humidity	5 to 95% RH, Non-condensing			

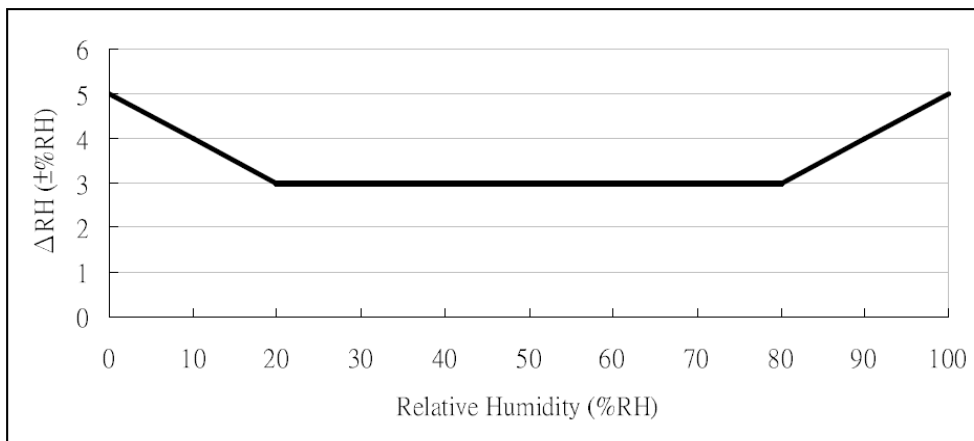

Figure 1: Maximum RH-tolerance at 25°C per sensor

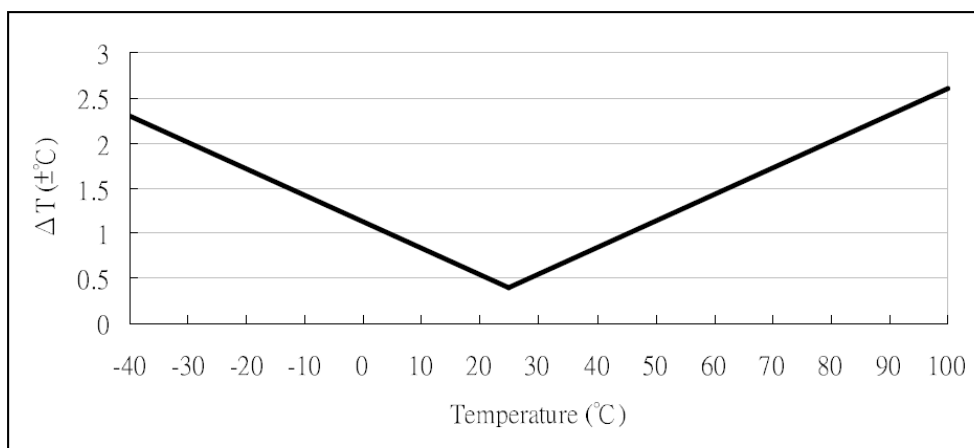
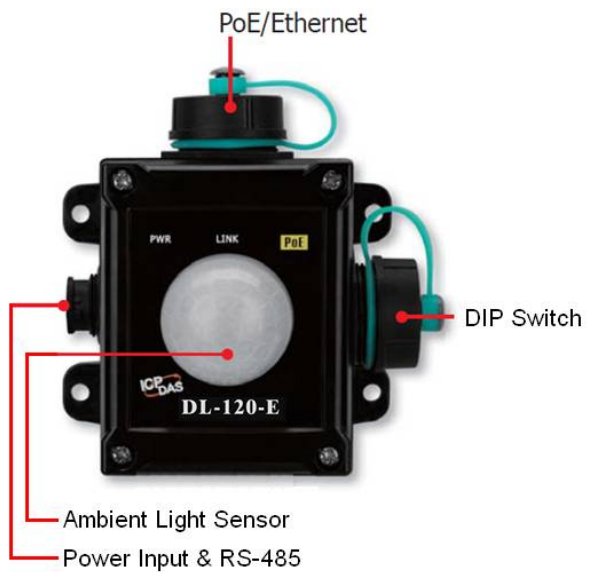
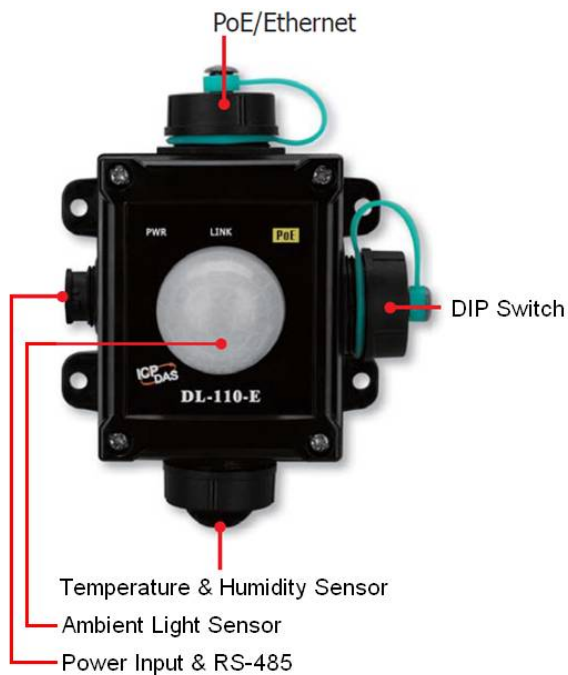
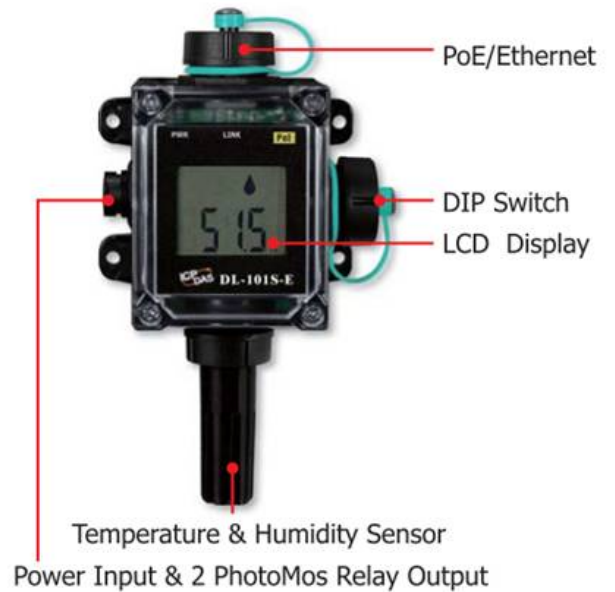

Figure 2: Maximum T-tolerance per sensor

2.2 Appearance



LED Indicators

The three LED indicators from left to right are:

- ▶ PWR: green for normal operation.
- ▶ Link: green for the Ethernet linked.
- ▶ PoE: red for powered via PoE

DIP Switch



The functions are printed on the top beside the SW1 DIP switch. All the 4 dip switches need be turned to the off position for normal operation.

1. Reserved
2. FW Update: ON for updating firmware.
3. Reserved
4. INIT: ON for using the factory default settings for communication

PoE/non-PoE Ethernet port

The Ethernet port can be used to connect to either a PoE switch or a non-PoE switch.



Installing a waterproof attachment on an RJ45 connector.

The DL-100S-E series module is equipped with an RJ-45 waterproof connector that ensures the device is able to withstand potential contaminants in dusty environments.

IP67 RJ45 Plug (4SASO-0001)



Installation procedure:

To install the waterproof connector, follow the procedure described below.

Step 1: Remove the RJ-45 Connector from the RJ-45 Cable



Step 2: Feed the end of the two core power cable through the Sealing Nut, Seal, Lock Nut, Clamp Ring and Gasket

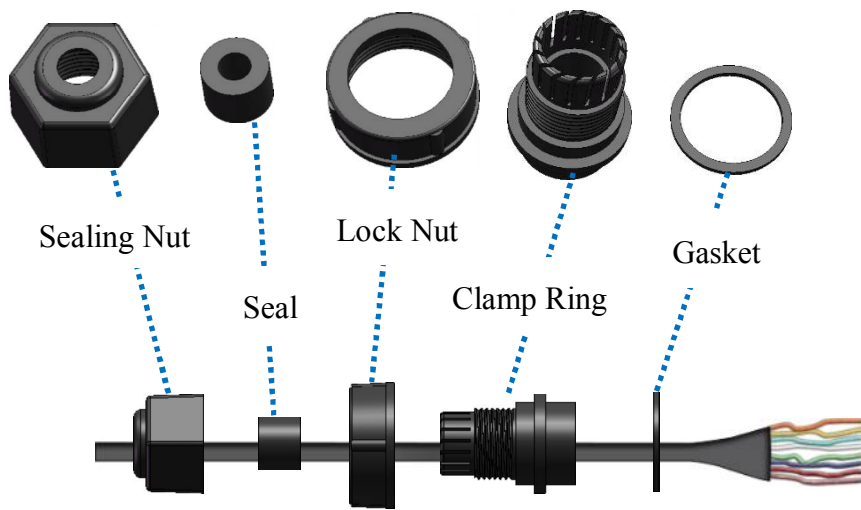

Step 3: Wrap the Gasket around the Clamp Ring

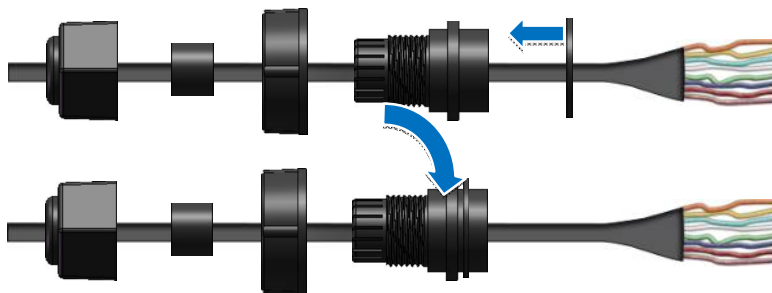

Step 4: Wrap the Lock Nut around the Clamp Ring

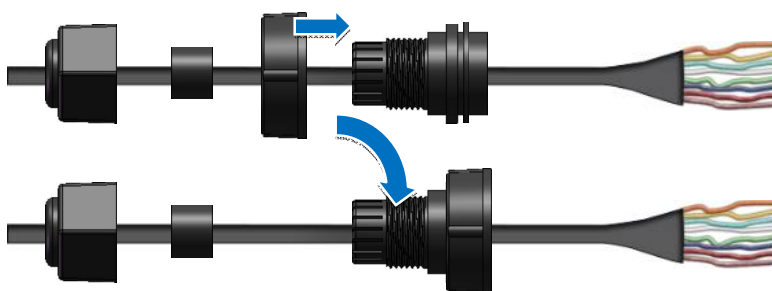

Step 5: Insert the Seal around the Clamp Ring

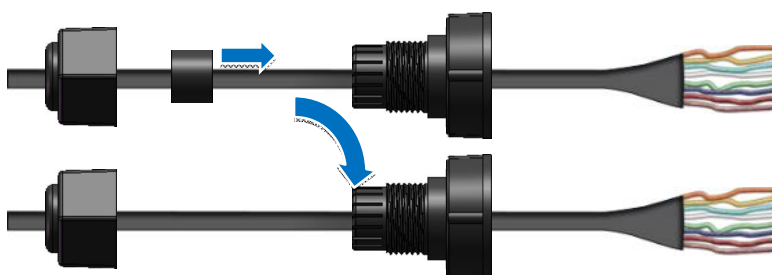

Step 6: Push the **Seal Nut** forward and Hand-tighten it to seal the assembly

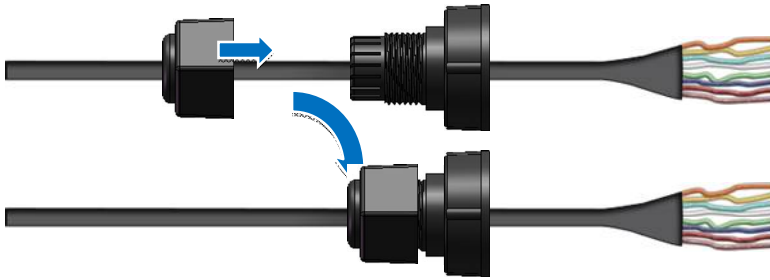

Step 7: Insert the **RJ-45 Cable** into the **RJ-45 Connector**

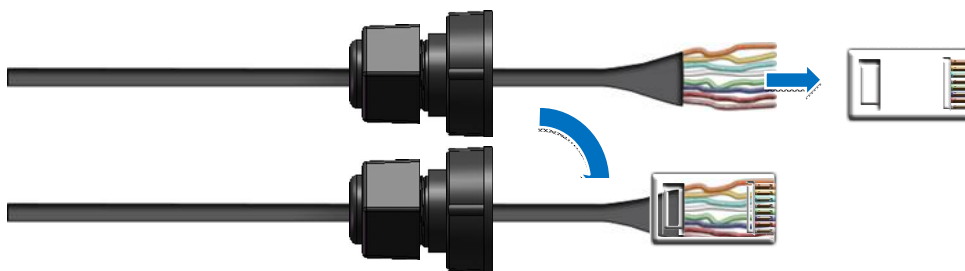

Step 8: Push the RJ-45 waterproof connector assembly forward so that it covers the RJ-45 connector



Step 9: Connect the RJ-45 Cable to the COM Port on the DL-100S-E module



Step 10: Firmly tighten the connector to the module and ensure that it is completely connected.



Connector for Power / Alarm Relay Output / RS-485

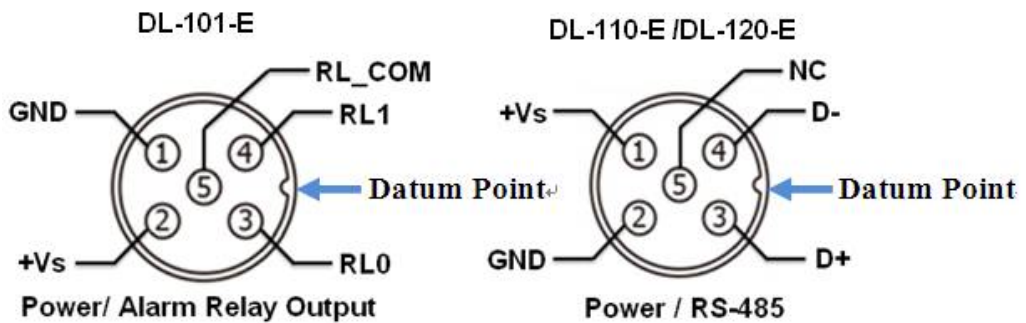

Step 1: Feed the end of the two core power cable through the Sealing nut, Seal, Clamp Ring, Gasket and Lock Nut

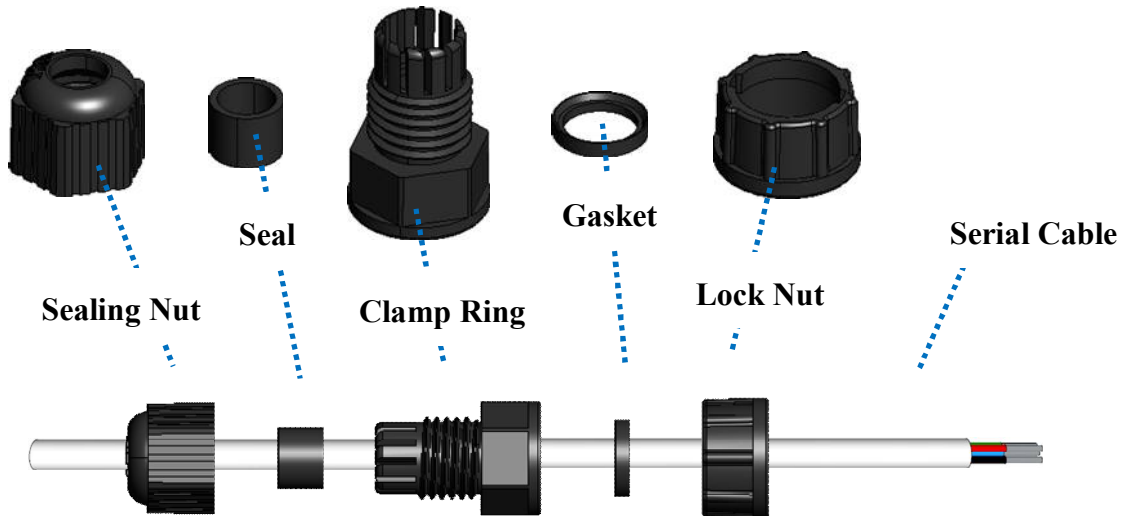

Step 2: Insert the conductors into the holes on the 5 Pin Cable Connector. See the figure below for the correct pin-out connections



Step 3: Wrap the Lock Nut around the 5 Pin Cable Connector

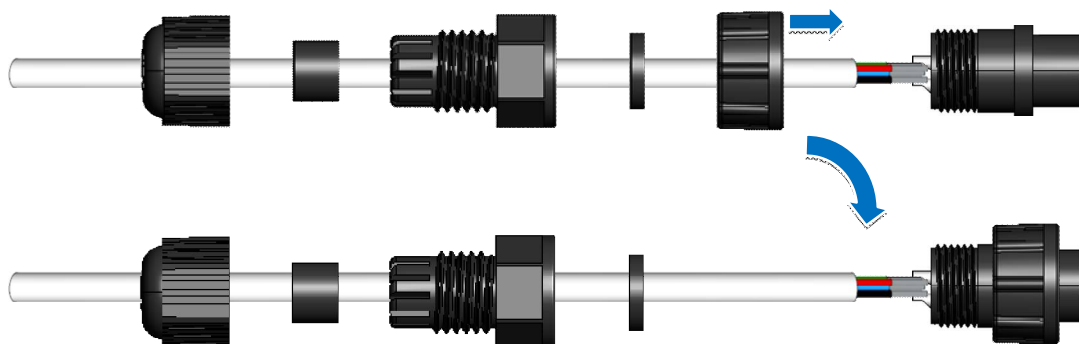

Step 4: Insert the Gasket into the Clamping Ring

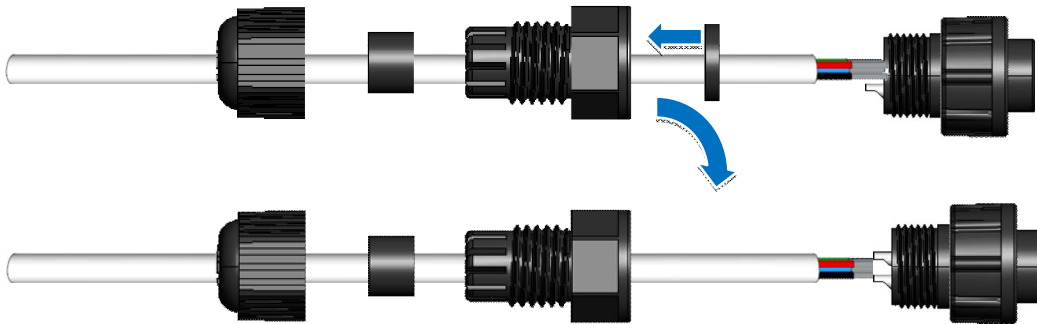

Step 5: Wrap the Clamp Ring around the 5 Pin Cable Connector

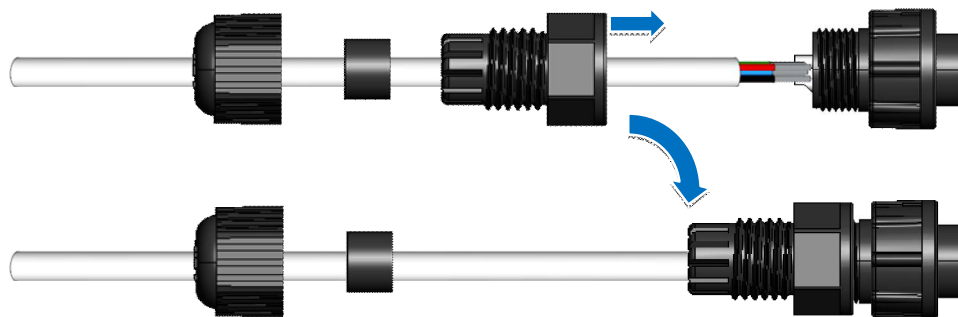

Step 6: Insert the Seal into the Clamp Ring

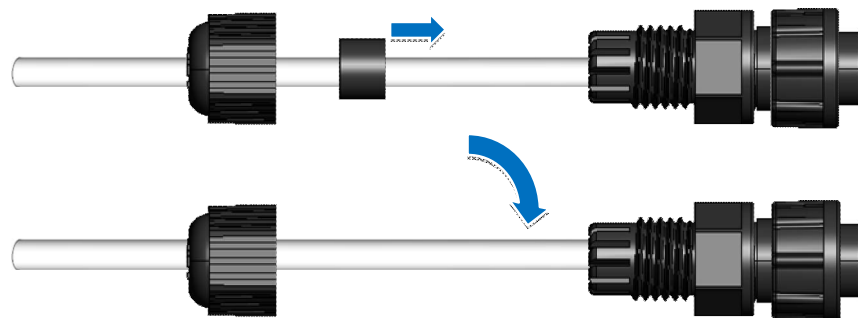

Step 7: Push the Sealing Nut forward and Hand-tighten it to seal the assembly

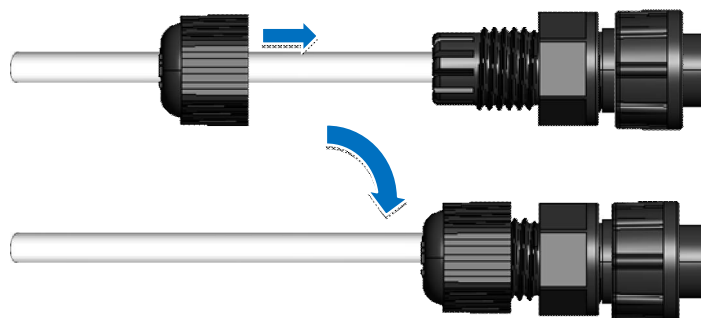

Step 8: Wrap the O-Ring around the 5 Pin Cable Connector

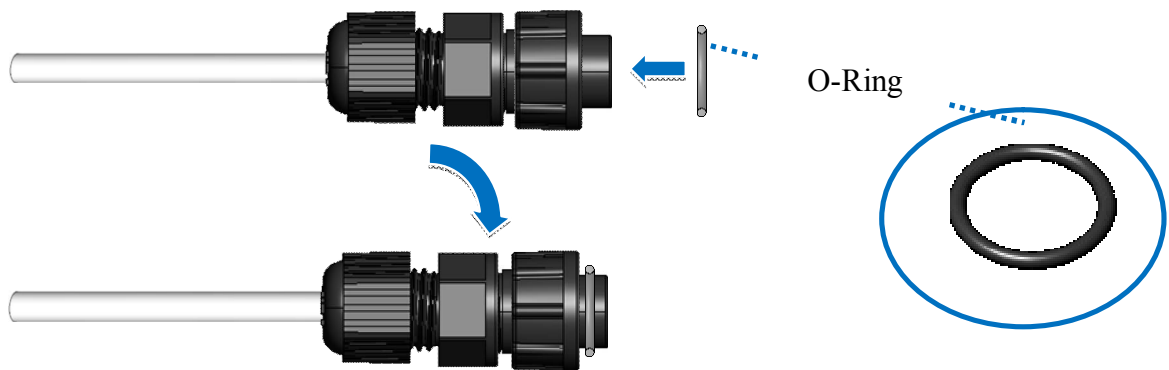

Important: Make sure to tighten firmly.

Step 9: Connect the Power cable to the Power socket on the DL-101S-E / DL-110-E/ DL-120-E module

The fool-proofing groove (as red circle) is useful for easy connection of power cable and power plug. Please make sure they are located in the same direction when connecting these two items.



Relay Output Wire Connection (DL-101S-E Only)

Output Type	ON State Readback as 1	OFF State Readback as 0
Relay Output		

2.3 Dimensions (unit: mm)

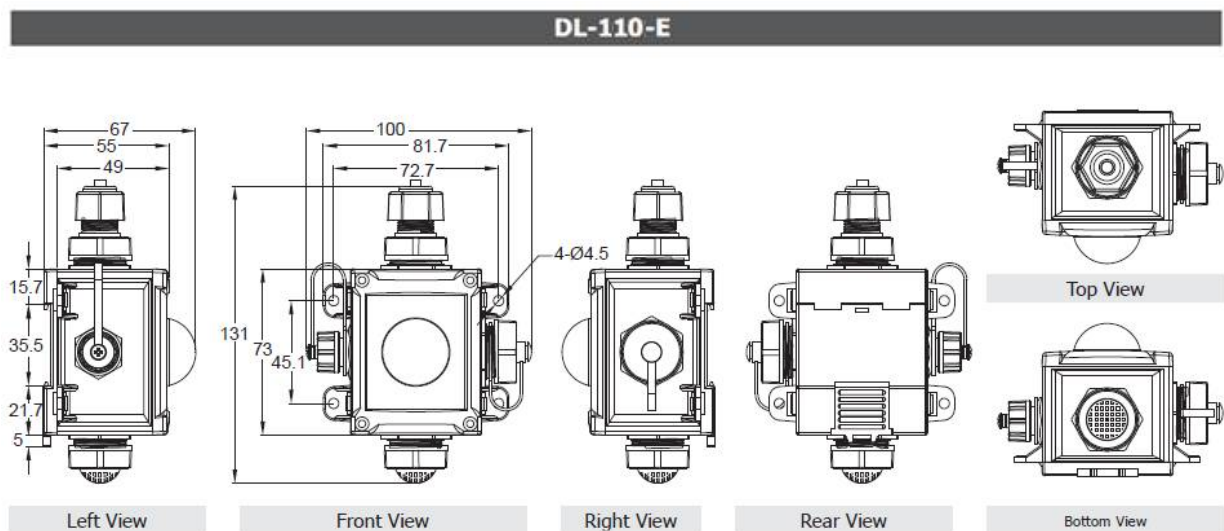
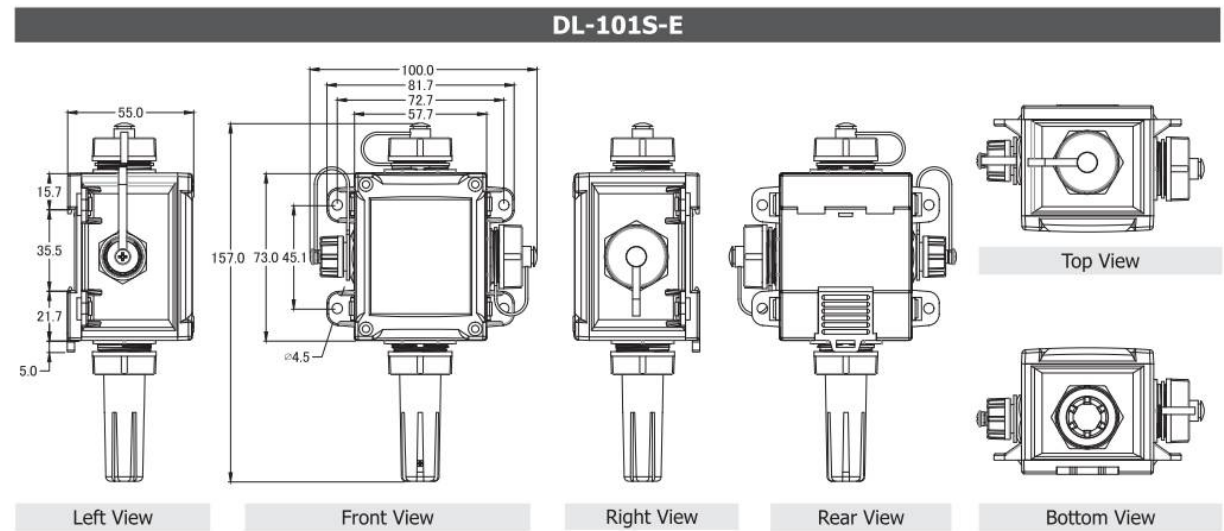
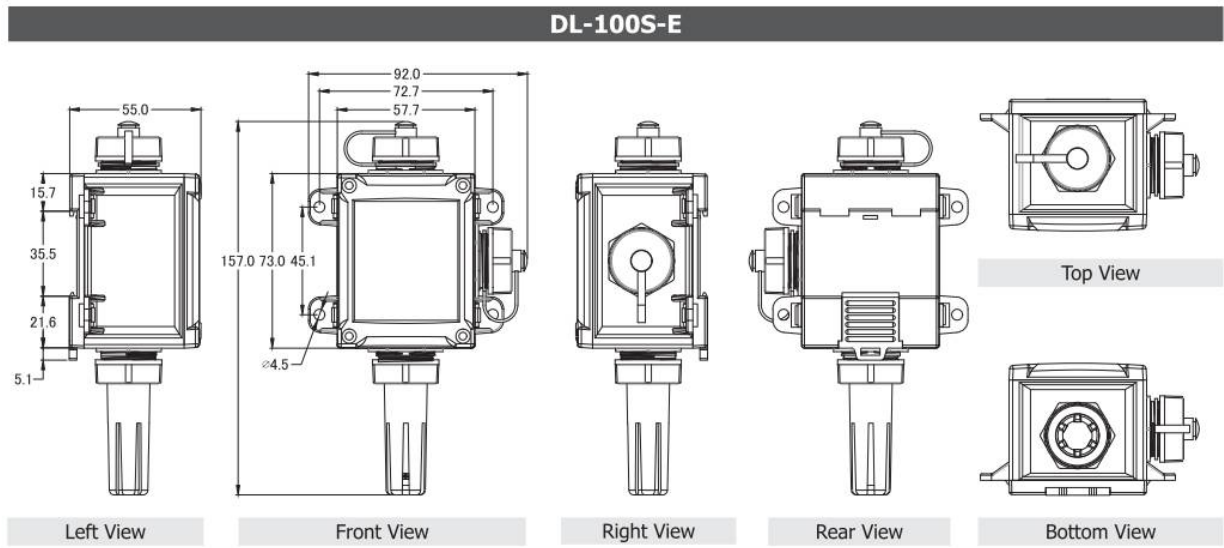

DL-120-E

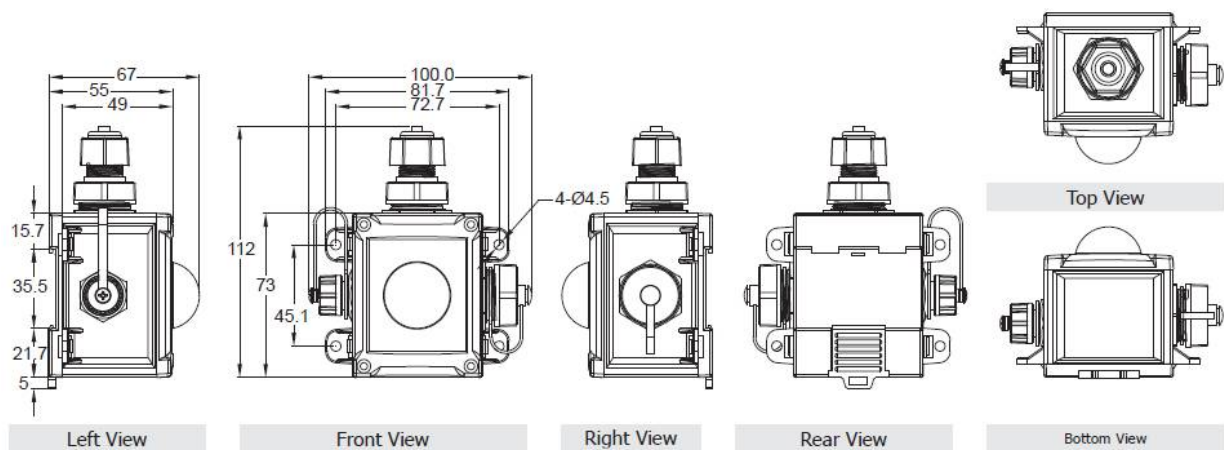

2.4 Cabling for Power and Network

Note

- Do not install the DL-100S-E series module near a vent, a ventilation fan or a door where the air flows faster.
- Avoid installing in locations where the temperature is below -20°C or above 60°C .
- Avoid installing in locations near a strong electromagnetic field.

For connecting with a PC or a Android device

Connecting to a PC or an Android device

The DL-100S-E series module can be connected to either a PoE network without a power source, or to a non-PoE network, as illustrated in the diagram below. When using the Search function via Wi-Fi on the iAir App on either an Android or iOS mobile device, the mobile device must be connected to the same subnet as the DL-100S-E series module. Similarly, when using the Search function in the DL-300 Utility on Windows, the module, and the Host PC also need to be connected on the same subnet.

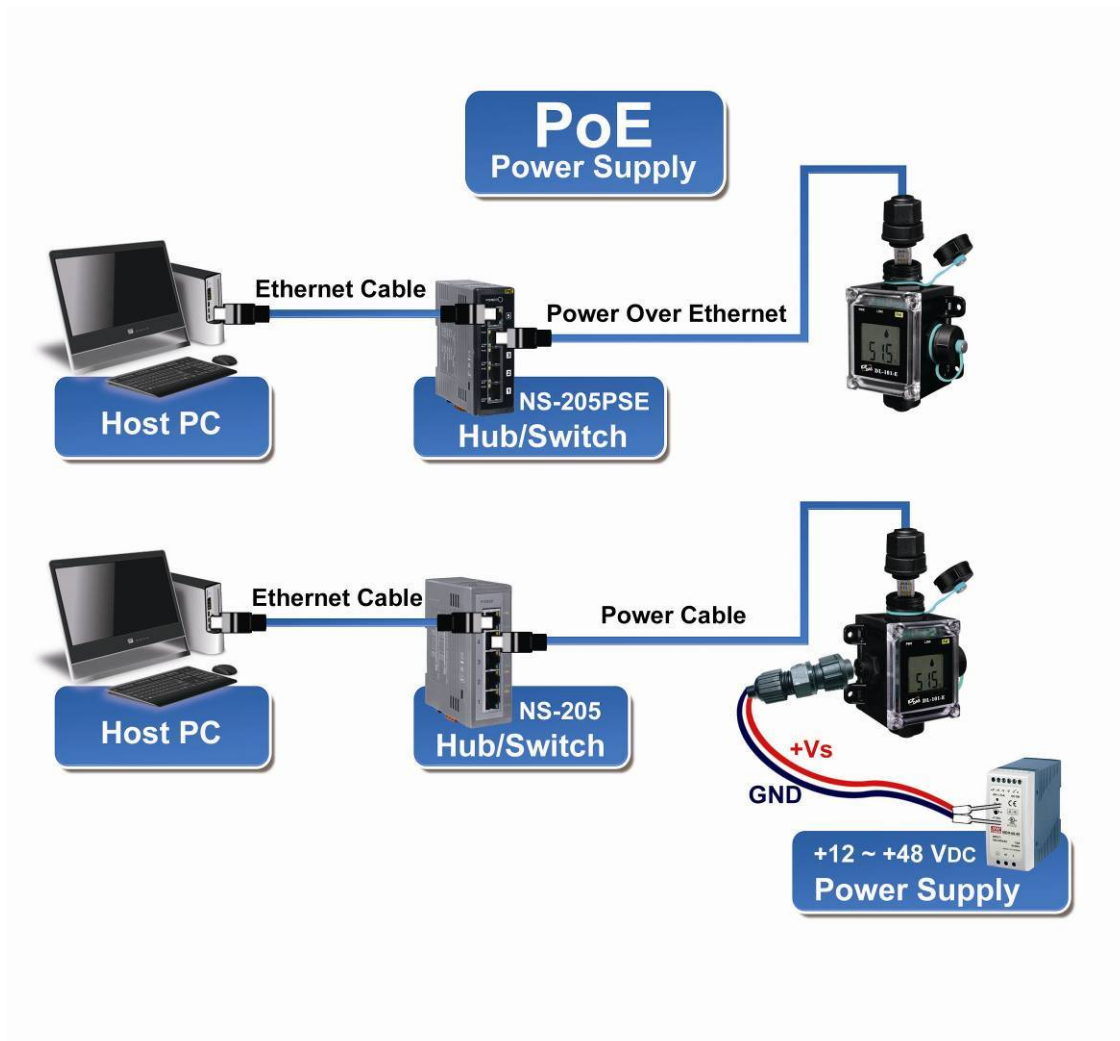

The iAir App from ICPDAS and the DL-300 Utility are able to search for loggers by broadcast, therefore only devices that exist on the same subnet can be searched for. This means that the Host PC, the Android device and the logger must have the same broadcast address. The broadcast address for an IPv4 device can be obtained by performing a bitwise OR operation between the bit complement of the subnet mask and the IP address for a device. In other words, take the device's IP address, and set any bit positions that have a '0' in the subnet mask to '1'.

For example, in an entire IPv4 subnet, the Host PC or the Android device uses the private IP address space 172.16.0.0/12 and the subnet mask address 255.240.0.0, therefore the broadcast address is $172.16.0.0 \mid 0.15.255.255 = 172.31.255.255$.

Consequently, only loggers that have the same broadcast address can be identified in the iAir App or the DL-300 Utility. Contact your network administrator to ensure the DL-100S-E series logger is connected to the same sub-network as your Android device or PC.

3. Configuration via Web Browser

The DL-100S-E series logger has a built-in web server that provides simple web pages for remote monitoring real-time data and configuring the logger with a standard browser. For opening the web page in DL-100S-E series module, the factory default IP address (192.168.255.1), Subnet Mask (255.255.0.0) and Gateway (192.168.0.1) need be set to available IP/Subnet Mask/Gateway addresses in your Ethernet environment. The Ethernet configuration can be set by entering the Settings menu from the web pages.

3.1 Search the DL-100S-E series module logger

eSearch is designed to search out the DL-100S-E series logger connected on the same Ethernet network, it supports for Linux and Windows and is needless to install.

The eSearch can be downloaded from

<http://ftp.icpdas.com/pub/cd/iiot/utility/>

Before running eSearch, turn off firewall on computer, and connect the computer and DL-101S-E logger to Ethernet network.

1. Launch eSearch, click the **Search Servers** button to search the DL-100S-E modules connected to the network, the modules searched out will be listed as below.
2. Double click the module name searched in the list.

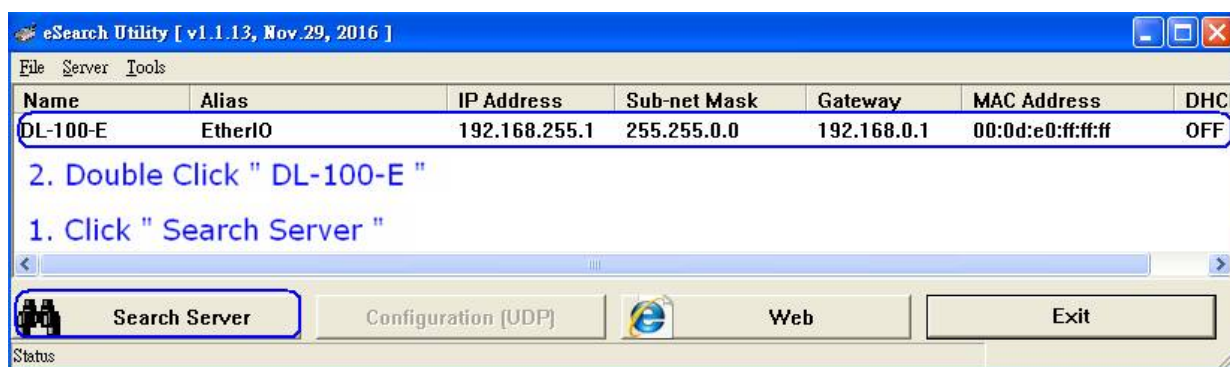

3. Set available IP Address, Sub-net Mask, Gateway (designated by your network administrator) and alias and click the **OK** button. The Alias for easy to identify each item will be shown at the bottom-left corner of the DL-100S-E screen.



Refer to “Chapter 3.1 Search the DL-100S-E logger. If the IP address settings do not work correctly,

3.2 Logging into the DL-100S-E

1. Enter the IP address for your DL-100S-E in the address bar of a web browser.
2. Type the Login password, and click the **Submit** button.
(The default Login password is **Admin**, case sensitive.)

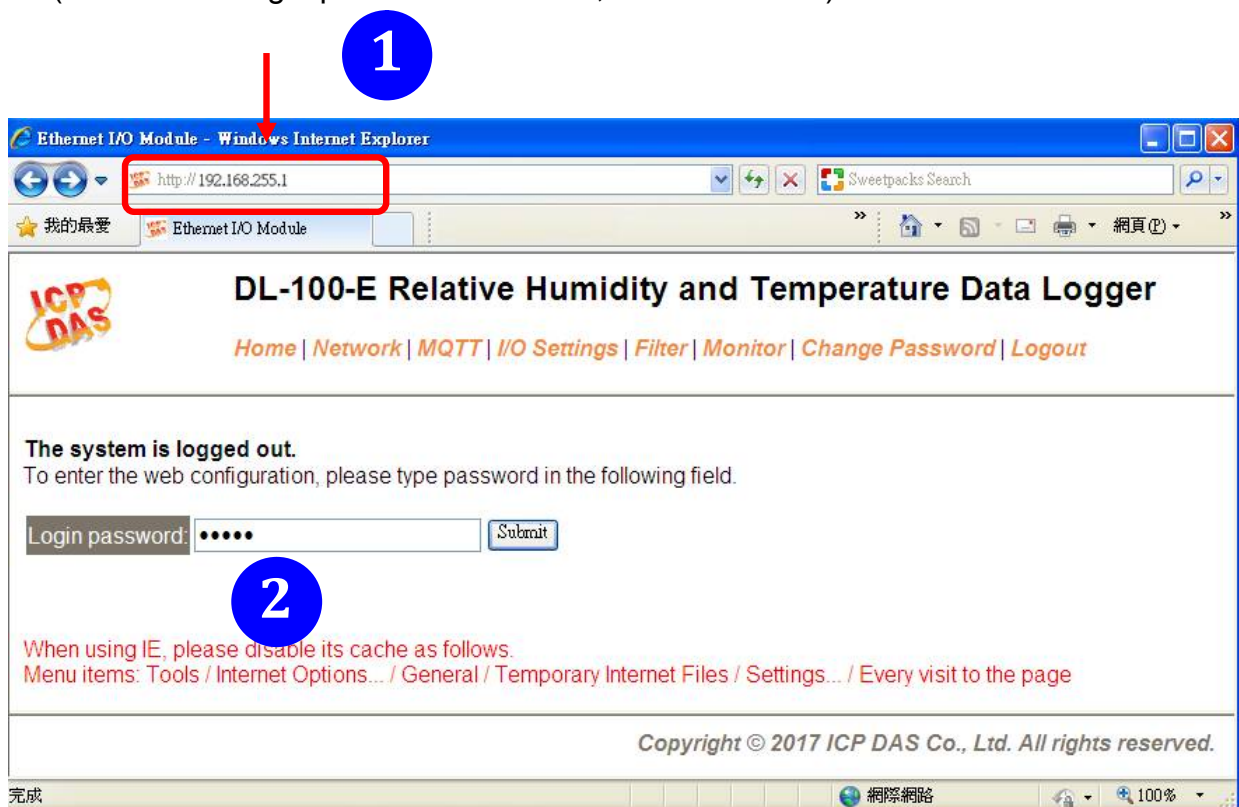

3.3 Home

The first page displayed is **Home**, it shows the based configuration of the DL-110-E module and the real-time data as below:

Status & Configuration

Model Name	DL-110-E	Alias Name	EtherIO
Firmware Version	B4.2 [Dec.10, 2018]	MAC Address	00-0D-E0-FF-FF-FF
IP Address	10.1.0.67	TCP Port Timeout (Socket Watchdog, Seconds)	180
Initial Switch	ON	System Timeout (Network Watchdog, Seconds)	0

Sensor Readings

Type	Value	Low Latched	High Latched
Relative Humidity	72.1%	72.1%	74.6%
Temperature	19.0 °C	18.7 °C	19.0 °C
Dew Point	13.8 °C	13.8 °C	14.1 °C
Ambient Light	252 lux	61 lux	281 lux



In the **Sensor Readings** field is the real-time data of temperature, humidity, dew point and ambient light, the minimum value (Low Latched) and maximum value (High Latched) logged. Clicking on the **Clear Low Latched** button and the **Clear High Latched** button can reset the latched data to current value and latch new minimum or maximum value.

Alarm

Type	Alarm Mode	Low Alarm Limit	High Alarm Limit	Low Alarm Status	High Alarm Status
Relative Humidity	Disabled	0.0%	100.0%	Off	Off
Temperature	Disabled	-50.0 °C	100.0 °C	Off	Off
Dew Point	Disabled	-50.0 °C	100.0 °C	Off	Off

The Alarm table displays the settings of alarm mode, high alarm limit for temperature, humidity and dew point, low alarm limit for temperature, humidity and dew point, and the alarm status for each. Clicking on the **Clear Latched Alarm** button can clear the activated alarm status.

Digital Output

DO0		
DO1		

The **Digital Output** table shows the status of the relay output and the control button **Set Digital Output** to change the relay output status. The control function is invalid when any of the alarm modes is not disabled. If one of the alarm modes is enabled, the relay is linked to the alarm status for tapping audible/visual alarm.

At the end of the page are the data, time and device online time since powered on.

RTC

Date	2017-11-10	Time	17:37:06
------	------------	------	----------

Device Online Time

Device Online Time	0 Days, 00H:12M:32S
--------------------	---------------------

3.4 Network

The networks parameters are set on this page including DHCP enabled/disabled, IP/Subnet Mask/Gateway addresses, the port number and the NetID for Modbus TCP communication. Remember to click on the **Update Settings** button to update new parameters.

IP Address Configuration

IP Address	
Address Type	Static IP <input type="button" value="v"/>
Static IP Address	10 . 1 . 0 . 25
Subnet Mask	255 . 255 . 0 . 0
Default Gateway	10 . 1 . 0 . 254
MAC Address	00-0D-E0-FF-FF-A2 (Format: FF-FF-FF-FF-FF-FF)
Modbus TCP Slave	
Local Modbus TCP port	502 (Default= 502)
Local Modbus NetID	1 (Default= 1) <input type="button" value="v"/> (Default= Enable)
<input type="button" value="Update Settings"/>	

General Settings

Ethernet Speed	Auto (Auto=10/100 Mbps Auto-negotiation)
System Timeout (Network Watchdog)	0 (30 ~ 65535 s, Default= 0, Disable= 0) Action:Reboot
TCP Timeout	180 (5 ~ 65535 s, Default= 180, Disable= 0) Action:Cut-off
UDP Configuration	Enable (Enable/Disable the UDP Configuration, Enable=default.)
Web Auto-logout	10 (1 ~ 65535 minutes, Default= 10, Disable= 0)
Alias Name	EtherIO (Max. 30 chars, part of the MQTT topic name)
<input type="button" value="Update Settings"/>	

Item	Description	Default
System Timeout (Network Watchdog)	Sets the timeout for rebooting a DL-101S-E logger when it is abnormal or failure to communicate. Range: 30 ~ 65535 (unit: second) 0 = Disable	0 (Disable)
TCP Timeout	Sets the timeout for disconnecting a TCP connection when a DL-101S-E does not receive data coming from the Ethernet port. Range: 5 ~ 65535 (unit: second) 0 = Disable	180
Web Auto-logout	Sets the timeout for logout the web server in a logger when there is no any operation from the web browser interface. Range: 1 ~ 65535 (unit: minute) 0 = Disable	10
Alias Name	Sets an alias name for easy to identify a DL-101S-E. The maximum length is 18 characters.	EtherIO

Restore Factory Defaults

Restore all options to their factory default states	<input type="button" value="Restore Defaults"/>
Forced Reboot	<input type="button" value="Reboot"/>

The **Reboot** button is used to reboot the DL-101S-E. After pressing the button, a user needs to login the DL-101S-E logger again to using the web interface.

The **Restore Defaults** button can be used to restore the following settings to factory default values.

Item	Factory Default
IP address type	Static IP
Static IP	192.168.255.1
Default gateway	192.168.0.1
Subnet Mask	255.255.0.0
MAC address	Factory MAC address
Modbus TCP port	502
Modbus TCP NetID	1
Modbus TCP NetID	Enabled
System Timeout	0 (disabled)
TCP Timeout	180 seconds
Web auto logout	10 minutes
Alias name	EtherIO
Accessible IP	Disabled

Firmware Update

<p>If the remote firmware update is failed, then the traditional firmware update (on-site) is required to make the module working again.</p> <p>Step 1: Refer to firmware update manual first. Step 2: Run eSearch Utility to prepare and wait for update. Step 3: Click the [Update] button to reboot the module and start update. Step 4: Configure the module again.</p>	<input type="button" value="Update"/>
---	---------------------------------------

The Update button is used to update firmware for DL-300-IP65 version. For details regarding firmware update, please refer to the section 6. FAQ Q4.

3.5 MQTT

MQTT stands for MQ Telemetry Transport, it is a publish/subscribe, extremely simple and lightweight messaging protocol, designed for constrained devices and low-bandwidth, high-latency or unreliable networks.

The Publish-Subscribe messaging pattern requires a message broker. The broker is responsible for distributing messages to interested clients based on the topic of a message. Now the MQTT Version 3.1.1 becomes an OASIS standard, it is an ideal protocol for communicating with connected devices in the emerging "machine-to-machine" (M2M) and "Internet of Things" applications, and for mobile applications where bandwidth and battery power are at a premium.

Connectivity Settings

MQTT	Disable ▼
Broker IP Address	192 . 168 . 255 . 10
Broker Port	1883 (Default= 1883)
Client Identifier	DL-101-E_920007
Alias Name	EtherIO (Max. 30 chars, part of the topic name)
User Name	(Max. 63 chars)
Password	(Max. 63 chars)
Reconnection Interval	10 (5 ~ 65535 s, Default= 10)
Keep Alive Interval	20 (5 ~ 65535 s, Default= 20)
Update Settings	

Input the IP address and port number for the MQTT broker and click on the **Update Settings** button to save the parameters.

Last Will Settings

Last Will and Testament	<input type="checkbox"/>
Topic	(Max. 30 chars)
Message	(Max. 30 chars)
QoS	0 - At most once ▼
Retained	<input type="checkbox"/>
Update Settings	

Publication Settings

Cycle	1000 (400 ~ 65500 ms, in 10 ms step, Default= 1000)
Publication Topic Format	(Module Topic Name)(Sub Topic Name) ▼
Module Topic Name	EtherIO/ (Max. 255 chars)
Relative Humidity Sub Topic Name	RH (Max. 63 chars) Enable ▼
Temperature (°C) Sub Topic Name	TC (Max. 63 chars) Enable ▼
Temperature (°F) Sub Topic Name	TF (Max. 63 chars) Enable ▼
Dew Point (°C) Sub Topic Name	DC (Max. 63 chars) Enable ▼
Dew Point (°F) Sub Topic Name	DF (Max. 63 chars) Enable ▼
Ambient Light Sub Topic Name	LUX (Max. 63 chars) Enable ▼
All Information Sub Topic Name	Info (Max. 63 chars) Disable ▼
Update Settings	

- Cycle: sets the time period for update the publish messages in millisecond.
- Module Topic Name: sets the module topic name.
- Relative Humidity/ Temperature (°C)/ Temperature (°F)/ Dew Point (°C)/ Dew Point (°F) / Ambient Light (LUX) Sub Topic Name: sets the sub topic name for each item.

A MQTT client subscribes the messages form a MQTT broker by specifying the topic name as

Subscription Settings

Subscription Topic Format	(Module Topic Name)(Sub Topic Name) ▾
DO0 Sub Topic Name	<input type="text"/> (Max. 63 chars)
DO1 Sub Topic Name	<input type="text"/> (Max. 63 chars)
<input type="button" value="Update Settings"/>	

Input the Message Attribute Sub Topic Name and Message Sub Topic Name, and then click on the **Update Settings** button to save the parameters. Users can remotely display message or set the message attribute by publishing MQTT messages to the topic name of [Module Topic Name + Message Sub Topic Name] or [Module Topic Name + Message Attribute Sub Topic Name]

- Message Attribute Sub Topic Name: sets the sub topic name for message attribute. If a MQTT message is published to topic name: "Module Topic Name + Message Attribute Sub Topic Name" for a DL-101S-E logger, the logger will follow the MQTT message described to set the attribute for displaying a message on the screen.

Note: the message attribute needs be passed before the message published to take the settings effect.

3.6 I/O Settings

Temperature

Scale	°C ▼
Update Settings	

Users can change the temperature unit to Fahrenheit or Celsius in this field.

Alarm Configuration

Type	Alarm Mode	Low Alarm Limit	High Alarm Limit
Relative Humidity	Disabled ▼	0.0	100.0
Temperature	Disabled ▼	-50.0	100.0
Dew Point	Disabled ▼	-50.0	100.0
Update Settings			

All the settings take effect after clicking the *Update Settings* button.

Item	Description	Default
Alarm Mode	<ul style="list-style-type: none"> - Disabled: Disables alarm function. - Momentary: If a measurement value higher than the High Alarm Limit or lower than the Low Alarm Limit, the alarm occurs until the measurement value is within a range from Low Alarm Limit to High Alarm Limit. - Latched: If a measurement value higher than the High Alarm Limit or lower than the Low Alarm Limit, the alarm occurs. 	Disabled
Low Alarm Limit	Sets the Low alarm limit conditions for Relative Humidity/ Temperature/ Dew Point.	
High Alarm Limit	Sets the High alarm limit conditions for Relative Humidity/ Temperature/ Dew Point.	
Beep On Alarm	Enable/disable beep on alarm for Temp /RH /Dew point	

Digital Output

Channel	Power On Value	Safe Value
DO0	Off <input type="button" value="v"/>	Off <input type="button" value="v"/>
DO1	Off <input type="button" value="v"/>	Off <input type="button" value="v"/>
Host Watchdog Timeout (seconds)	0 <input type="text"/> (5 to 65535 Seconds, Default= 0, Disable= 0)	
<input type="button" value="Update Settings"/>		

Set the Power On Value and Safe Value for the relay output, and the Host Watchdog Timeout timer for Ethernet communication; if a host does not send a command over the setting time, the Host Watchdog timeout occurs and the relay outputs the status set for Safe value. The settings for Power On Value and Safe Value are unavailable when any one setting in the Alarm Mode is enabled

RTC

Year	2017 <input type="text"/> (2000 to 2159)
Month	10 <input type="text"/> (1 to 12)
Date	1 <input type="text"/> (1 to 31)
Hour	0 <input type="text"/> (0 to 23)
Minute	0 <input type="text"/> (0 to 59)
Second	0 <input type="text"/> (0 to 59)
<input type="button" value="Update Settings"/>	

All the settings take effect after clicking the *Update Settings* button.

Data Logger

Status	Stopped	
Change Logging	Stop	<input type="button" value="v"/>
Overwrite on Full	No	<input type="button" value="v"/>
Sampling Interval - Hour	<input type="text" value="0"/>	(0 to 24)
Sampling Interval - Minute	<input type="text" value="0"/>	(0 to 59)
Sampling Interval - Second	<input type="text" value="10"/>	(0 to 59)
Period Start - Year	<input type="text" value="2017"/>	(2000 to 2159)
Period Start - Month	<input type="text" value="6"/>	(1 to 12)
Period Start - Date	<input type="text" value="1"/>	(1 to 31)
Period Start - Hour	<input type="text" value="0"/>	(0 to 23)
Period Start - Minute	<input type="text" value="0"/>	(0 to 59)
Period Start - Second	<input type="text" value="0"/>	(0 to 59)
Period End - Year	<input type="text" value="2017"/>	(2000 to 2159)
Period End - Month	<input type="text" value="6"/>	(1 to 12)
Period End - Date	<input type="text" value="2"/>	(1 to 31)
Period End - Hour	<input type="text" value="0"/>	(0 to 23)
Period End - Minute	<input type="text" value="0"/>	(0 to 59)
Period End - Second	<input type="text" value="0"/>	(0 to 59)
<input type="button" value="Update Settings"/>		

In this table it shows the settings for data logger.

All the settings take effect after clicking the *Update Settings* button.

Item	Description	Default
Status	<ul style="list-style-type: none"> - Running: the data logger is running - Stopped: the data logger is stopped 	
Change Logging	Sets the mode for data logger <ul style="list-style-type: none"> - Stop: stops the data logger - Run: continues logging data - Period: logs data in the specified period time 	Stop
Overwrite on Full	Sets whether to overwrite old data by new ones when the memory for data storage is full. (Over the upper limit of 600,000.) <ul style="list-style-type: none"> - No: discards the new data (default) - Yes: overwrites the old data by new ones 	No
Sampling Interval	Sets the time interval for logging data. It is valid for both Run mode and Period mode. <ul style="list-style-type: none"> - Sampling Interval – Hour: sets the hour for log interval - Sampling Interval – Minute: set the minute for log interval - Sampling Interval – Second: sets the second for log interval 	10 (s)
Period Start	Sets the start time for Period mode.	
Period End	Sets the stop time for Period mode	

LCD

Item	Display time (seconds) in a cycle
Temperature (°C)	1 <input type="text"/> (0 to 100)
Temperature (°F)	1 <input type="text"/> (0 to 100)
Relative Humidity	1 <input type="text"/> (0 to 100)
Date	1 <input type="text"/> (0 to 100)
Time	1 <input type="text"/> (0 to 100)
<input type="button" value="Update Settings"/>	

Note that all settings will take effect immediately after clicking the Update Settings button.

3.7 Filter IP

For limiting the devices to access the DL-100S-E logger, users can specify particular devices by setting their IP addresses on this page. When the addresses are 0.0.0.0 from IP1 to IP5, all the devices can access the logger. Once any of the 5 IP address columns is set, only the device with which IP is saved in the list can access the logger.

➤ Filter Settings

1. Select the radio button for *Add* ____ . ____ . ____ . ____ *To The List* and type the IP address for the accessible device in the following text box.
2. Click on the *Submit* button to the setting effect without restarting.
If the IP setting needs be saved for using after repowered, check the checkbox for *Save to Flash* before clicking the *Submit* button.

Filter Settings:

Available IP List	IP Address
IP1:	0.0.0.0
IP2:	0.0.0.0
IP3:	0.0.0.0
IP4:	0.0.0.0
IP5:	0.0.0.0

Add . . . To The List

Delete IP#

Delete ALL

Save to Flash

➤ Delete IP setting

Select the radio button for *Delete IP#* to delete a specified IP or the radio button for *Delete All* to delete all the IP, check the checkbox for *Save to Flash* and then click the *Submit* button to take the delete operation effect.

3.8 Monitor

This is only available to the RevB version or firmware version B3.9 and later. It lists the IP of the devices which are connected to the DL-101S-E module.

Current Connection Status:

Server Mode	Server
Connected IP1:	10.0.11.3
IP2:	0.0.0.0
IP3:	0.0.0.0
IP4:	0.0.0.0
IP5:	0.0.0.0
IP6:	0.0.0.0
Available Connections:	31

3.9 Change Password

On this page users can change the passwords for login the logger and locking the touch screen. The factory default for the DL-100S-E touch screen has no password protection. After setting the password for touch screen, each time whoever wants to change to settings from the touch screed, the password will be requested.

➤ Change Web Password

The password for logging into the web page is **Admin** and can be changed in the *Change Web Password* field. The password can be alphabetic characters or numbers and up to 12 characters (case sensitive).

To change the password, uses need enter the *Current password*, *New password*, and *Confirm new password* columns and click the Submit button for Change Web Password to take the setting effect.

Change Password

The length of the password is 12 characters maximum.

Current password:	<input type="text"/>
New password:	<input type="text"/>
Confirm new password:	<input type="text"/>
	<input type="button" value="Submit"/>

3.10 Logout



DL-101S-E Relative Humidity and Temperature Data Logger

[Home](#) | [Network](#) | [MQTT](#) | [I/O Settings](#) | [Filter](#) | [Monitor](#) | [Change Password](#) | [Logout](#)

The system is logged out.

To enter the web configuration, please type password in the following field.



Login password:

When using IE, please disable its cache as follows

Menu items: Tools / Internet Options... / General / Temporary Internet Files / Settings... / Every visit to the page

Copyright © 2017 ICP DAS Co., Ltd. All rights reserved.

Click the Logout on any page to logout the DL-101S-E.

4. Configuration via RS-485(DL-110-E / DL-120-E Only)

The factory default settings for RS-485 communication

- Address: 1
- Protocol: Modbus/RTU
- Baudrate: 9600
- Parity: N,8,1
- Response Delay (ms): 0

Note



If there are multiple DL-110-E loggers connected to the same RS-485 network, each logger needs to be set with a unique RS-485 address. More than one module having the same address will cause communication failure.

4.1. Building the RS-485 Connection

1. Download the DCON Utility Pro from http://ftp.icpdas.com/pub/cd/iiot/utility/dcon_utility_pro/
2. Launch the DCON_UTILITY_Pro.exe.

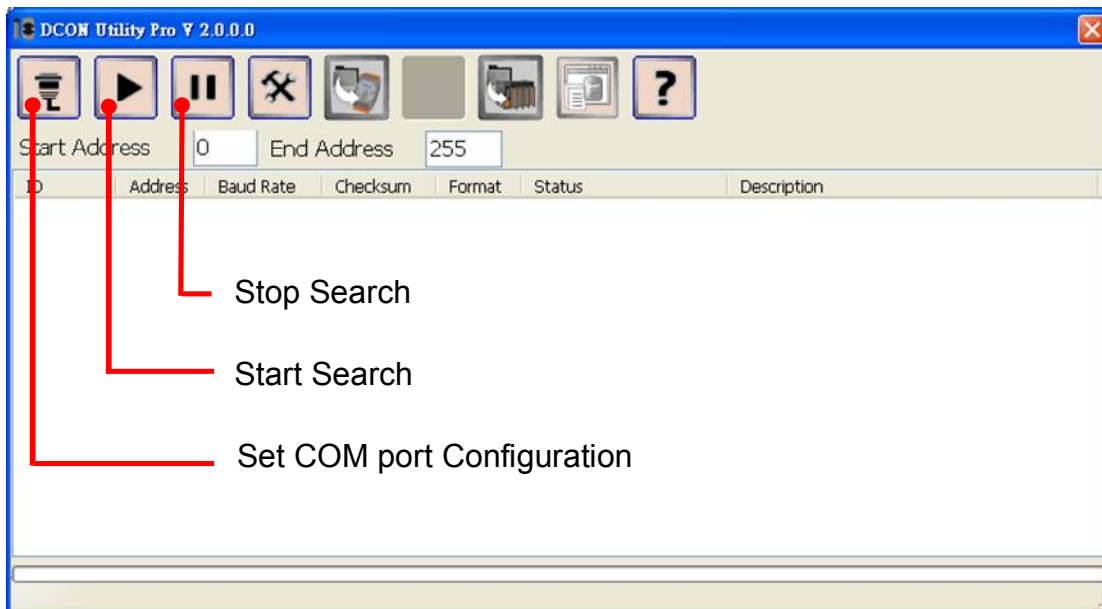

3. Click the  icon to configure the COM port.

4. Select the COM Port number used to connect the DL-110-E logger.

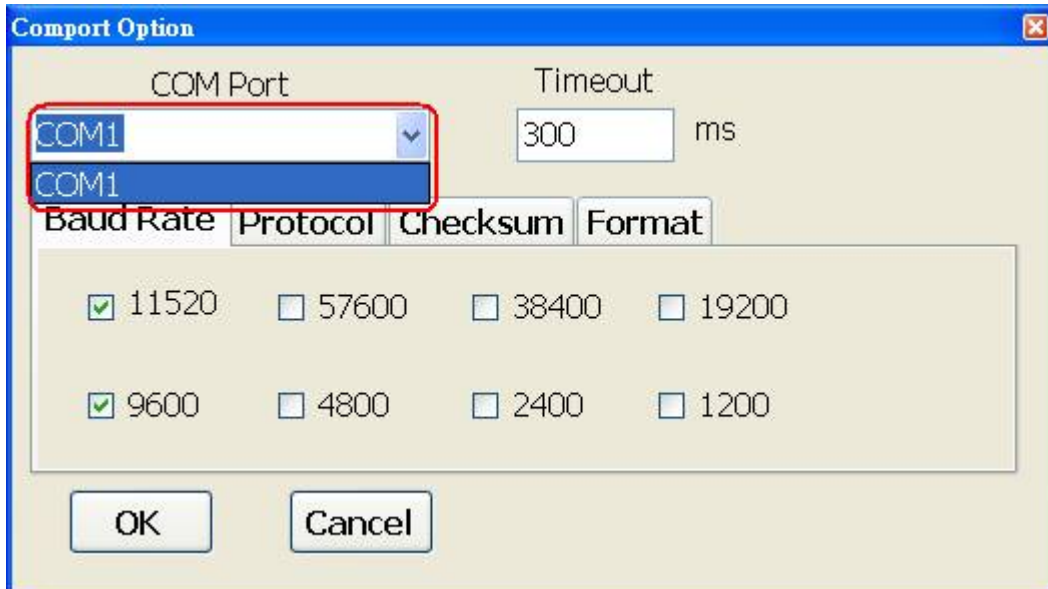

5. The Baud Rate is factory default to 9600 bps.

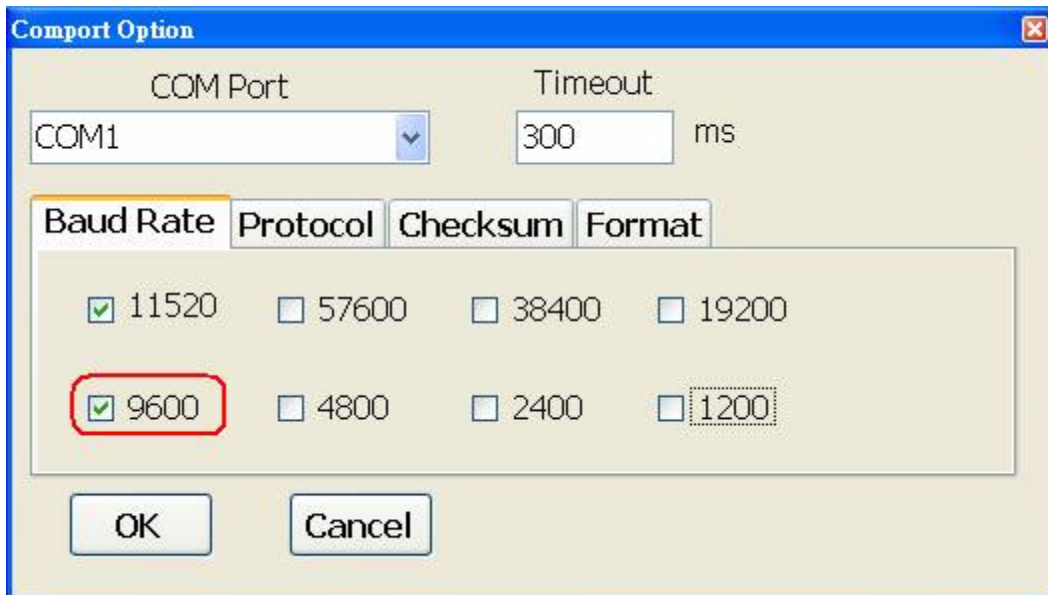

6. Select the Protocol tab and check the protocol that set in the logger.

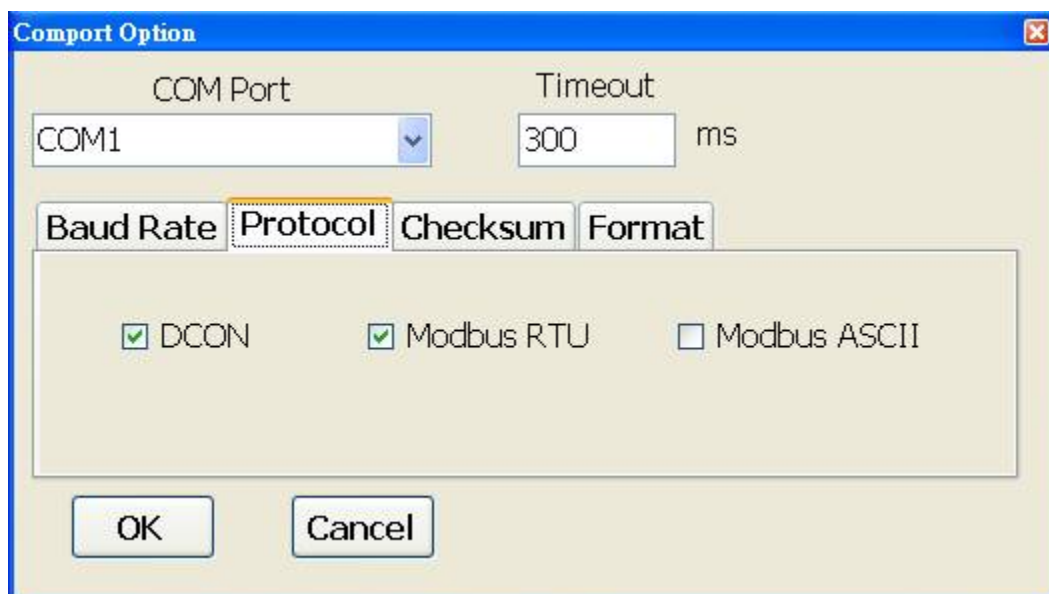

7. Select the Format tab and check the parity that set in the logger.

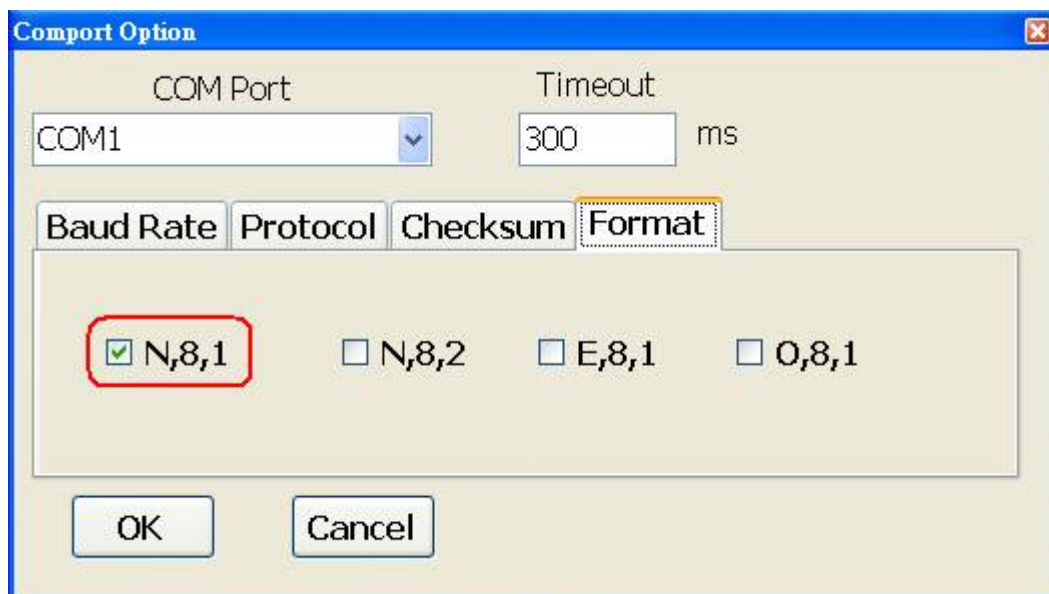

8. Click the Start Search icon.



9. The DL-110-E logger searched out will be listed as below.

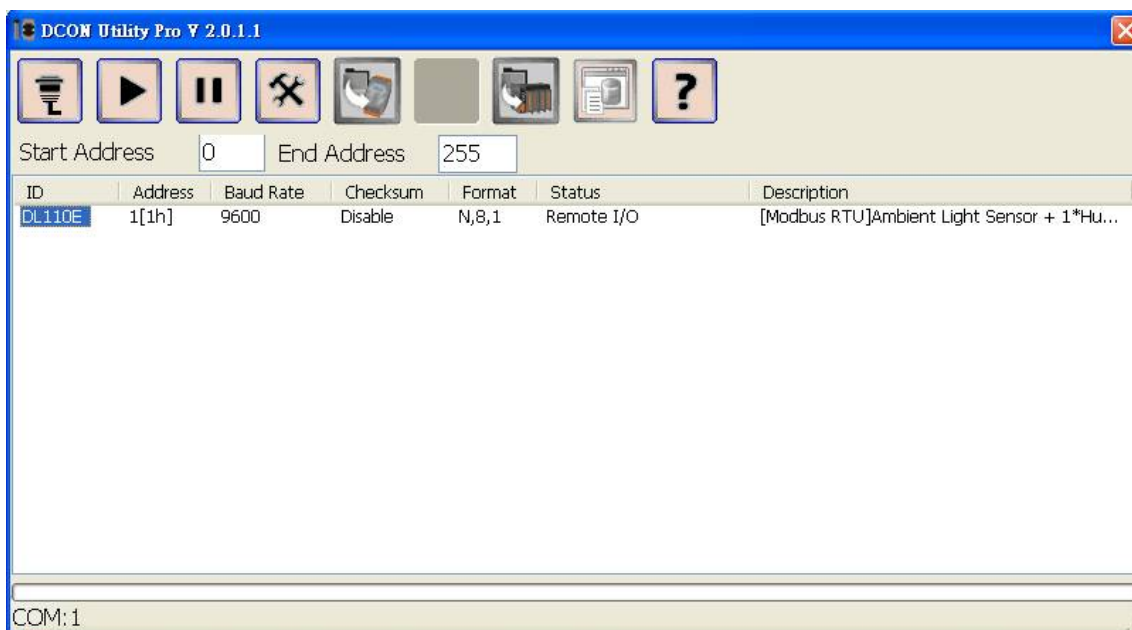

10. Click the module name to configure the logger.

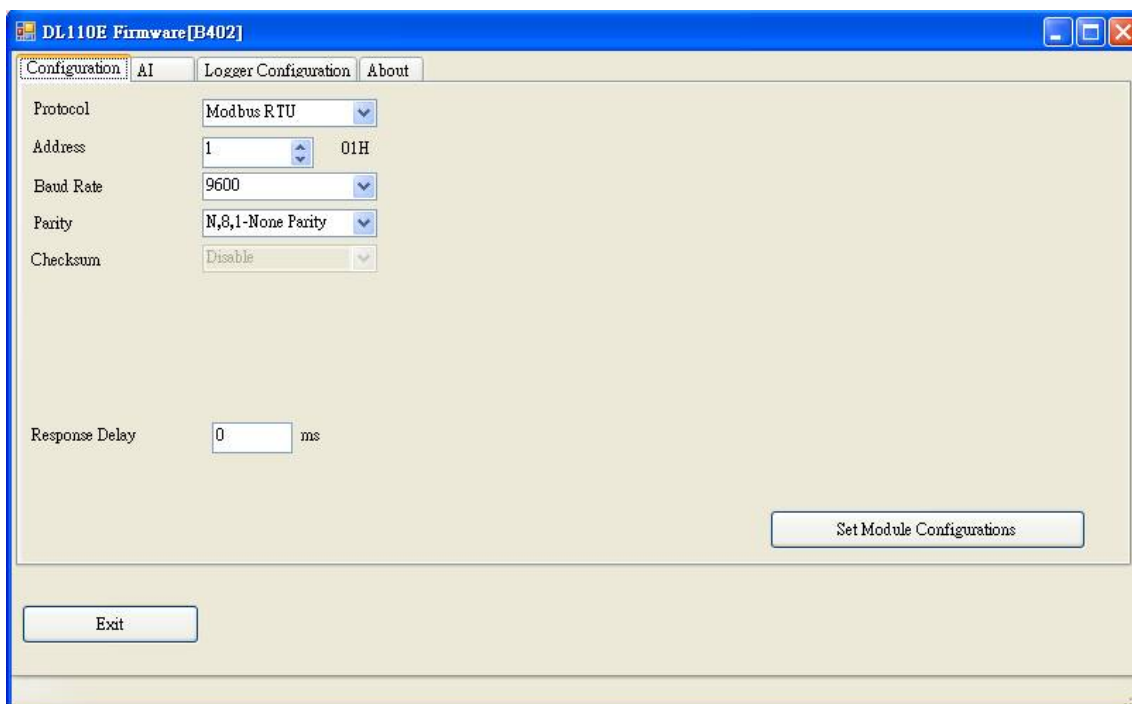

Not



The Protocol/Baud Rate/Parity/Checksum items marked with "(INIT*)" means that when any of those items needs be modified, the pin 4.INIT needs to be set in ON position and power cycle the logger, then the item can be modified. After complete setting, set the pin 4.INIT back to OFF position and power cycle the logger again to take the setting effect.

4.2. AI tab

In the AI form, you can read the sensor readings such as ambient light humidity, temperature and dew point temperature.

The screenshot shows the 'AI' configuration window of the DL110E Firmware. The window has a blue title bar and a menu bar with 'Configuration', 'AI', 'Logger Configuration', and 'About'. The main area contains several sensor configuration options:

- Ambient Light (lux):** A text box with the value '298'. To its right is a 'Degree of offset' section with radio buttons for '1' (selected) and '10', and a numeric input field set to '000.00' with '+' and '-' buttons.
- Humidity (%):** A text box with the value '067.11'. To its right is a 'Degree of offset' section with radio buttons for '1' (selected) and '0.1', and a numeric input field set to '000.00' with '+' and '-' buttons.
- Temperature Format:** Radio buttons for '°C' (selected) and '°F'.
- Temperature:** A text box with the value '019.33' followed by '°F'. To its right is a numeric input field set to '000.00' with '+' and '-' buttons.
- Dew Point Temperature:** A text box with the value '013.06' followed by '°C'.

Annotations with red lines point to various elements:

- 'Ambient Light' points to the '298' text box.
- 'Humidity' points to the '067.11' text box.
- 'Adjust the Ambient Light offset' points to the '000.00' offset field for Ambient Light.
- 'Adjust the humidity offset' points to the '000.00' offset field for Humidity.
- 'Adjust the temperature offset (°C)' points to the '000.00' offset field for Temperature.
- 'Temperature and Dew point temperature' points to the '013.06' Dew Point Temperature text box.

An 'Exit' button is located at the bottom left of the window.

4.3 Logger Configuration

In the Data Logger form, you can change the data logger related settings. Click on the Apply button to save the changes to the module.

DL110E Firmware [B402]

Configuration AI **Logger Configuration** About

Real Time Clock Year Month Day Hour Minute Second
2000 01 01 01 07 23

Log Status

Log Command 0: Stop

Overwrite Option 0: No Continue writing when data logger is full

Sample Period Hour Minute Second
00 00 10

Start Logger Time Year Month Day Hour Minute Second
2014 06 01 00 00 00

End Logger Time Year Month Day Hour Minute Second
2014 06 02 00 00 00

Apply

Exit

5. Monitoring via Mobile Devices

The iAir App can be used to monitor real-time data of temperature and humidity anywhere and anytime without any complicated configuration. The DL-100S-E series module and your mobile devices such as smart phones or tablets need be addressed on the same network, and then you can get the real-time data from DL-100S-E series module loggers by entering a specific IP address, or by performing an automatic search for available devices.

If a DL-100S-E series module cannot be searched in the iAir App, please contact with the network administrator to make sure the module and your mobile devices are addressed on the same sub-network. It means that they have the same broadcast address.



The iAir app is available to free download in Google Play and App Store. Search “iAir” in or search “iAir”, “ICPDAS” in App Store and tap on install.

The iAir user manual can be obtained from
<http://ftp.icpdas.com/pub/cd/iiot/utility/>

6. Utility to Get/Manage Data Log

DL-300 Utility is a convenient, easy-to-use management utility running on Windows platform that allows users to monitor the real-time data and trend chart from DL-100S-E series modules on the Ethernet, it can group the DL-100S-E series modules for group view management, log alarm events with timestamp, download the logged data from a DL-100S-E series logger and export the data to *.csv files for performing statistical analysis in Excel.

The DL-300 Utility can be obtained from:

http://ftp.icpdas.com/pub/cd/iiot/utility/dl300_utility/

1. Run the DL-300_utility_setup_yyyymmdd.exe, the default install location is C:\ICPDAS\DL300_UTILITY\DL-300 Utility

2. Open the DL-300 Utility by double clicking on the DL-300 Utility shortcut on desktop.



3. Search out a DL-100S-E module on the Ethernet and set the configuration.

3-1. Select the **Device Settings** on the **Settings** menu.

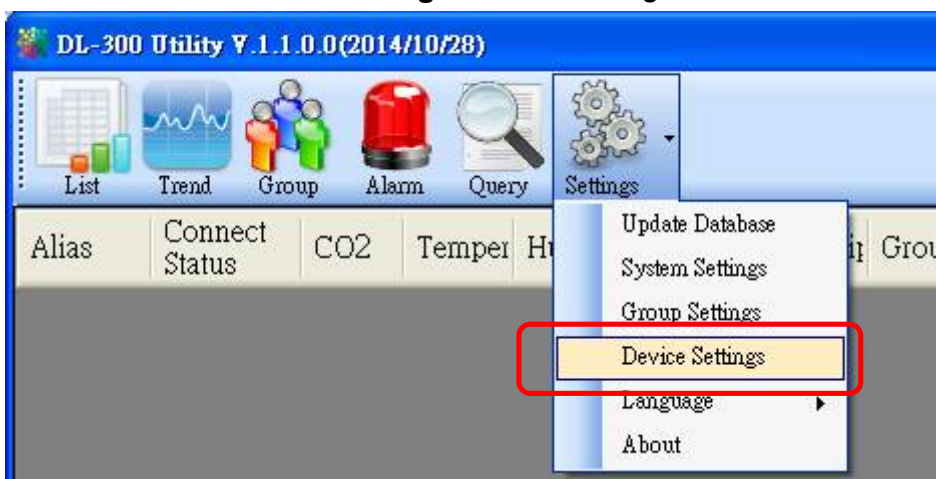

- 3-2. Click the **Search New Device** button to search the DL-100S-E modules connected on the same Ethernet network.
- 3-3. Check the checkbox next to a module and click the **Add** button to add the module in the utility.
- 3-4. Highlight a module and click the **Edit Device** button to configure the module.

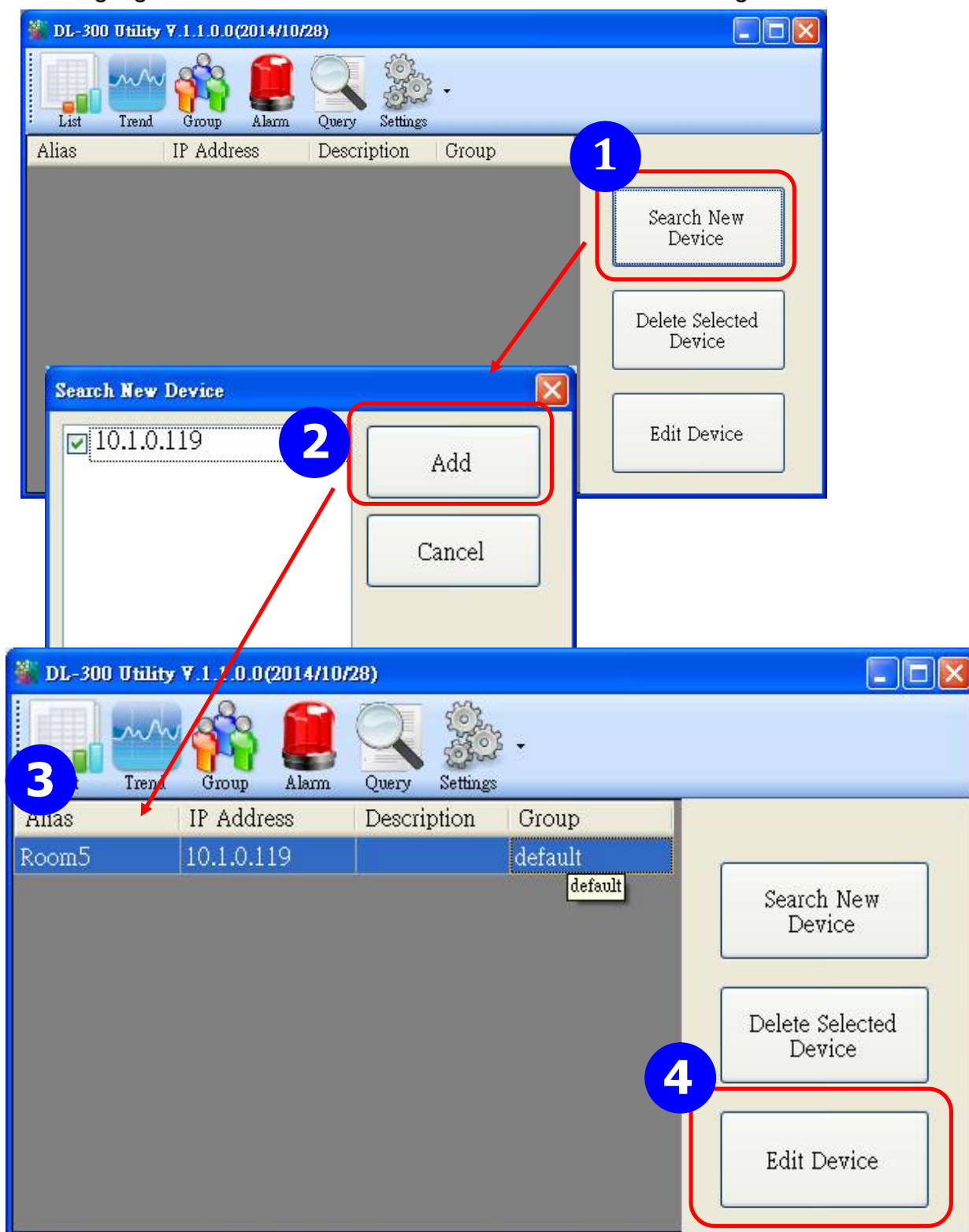

3-5. Set the configuration, and click on the **OK** button.

Note

Consult your network administrator before making changes to IP Address/ Mask Address/ Gateway

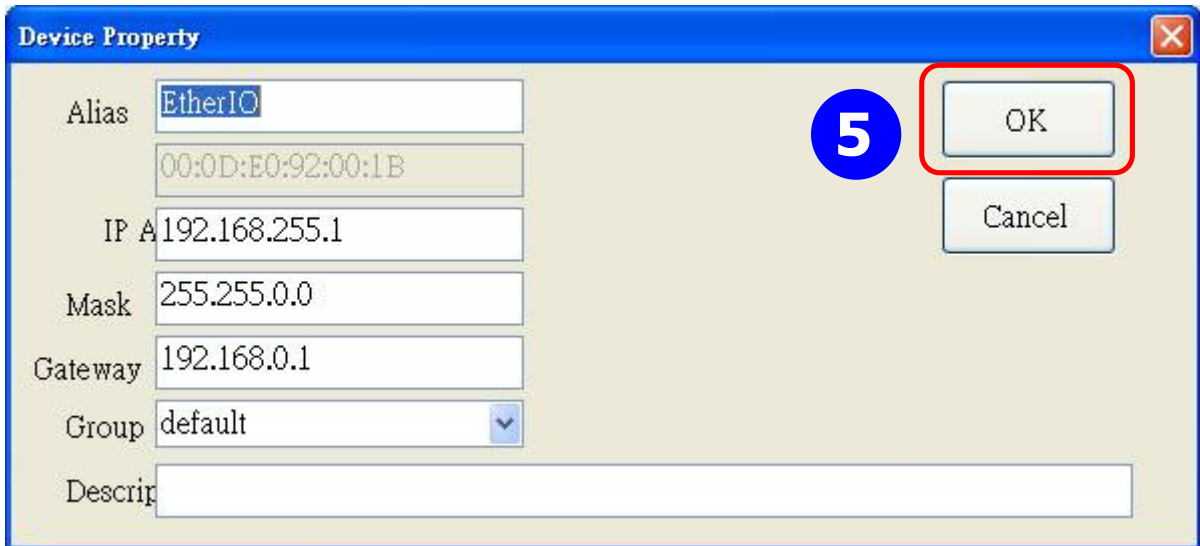

4. Get real-time data, trend chart and alarm event.

4-1. Click the **List** icon to obtain the real-time data. It also lists the connect status, group information and IP address for every DL-100S-E logger.

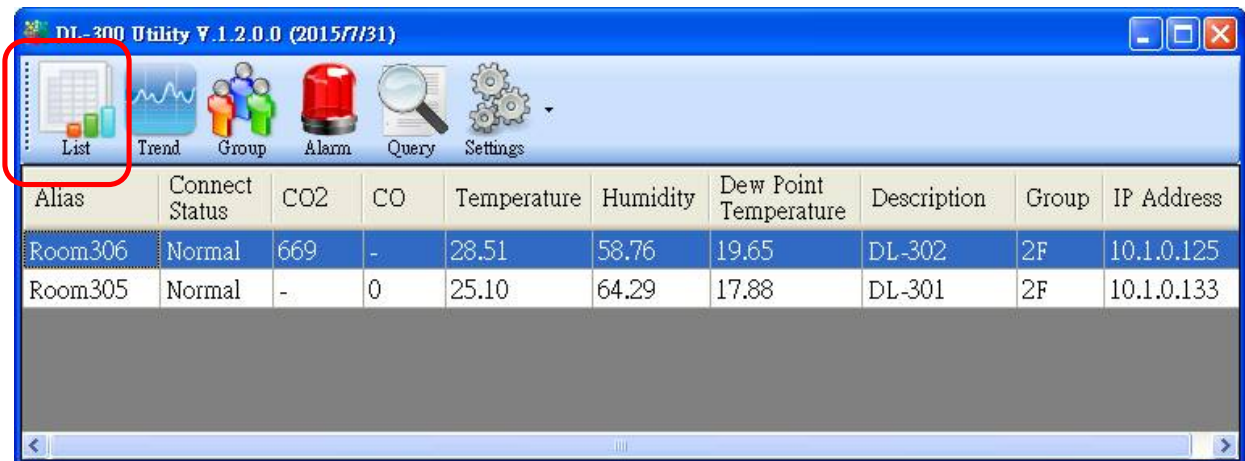

4-2. Click the **Trend** icon to display the trend chart. Users can select the radio button for CO/CO₂ level, Temperature or Humidity to access the trend chart for those real-time data, check the checkbox next to each DL-100S-E logger to display its trend chart or uncheck it to cancel display. Drag and drop the trend chart can move it to see the data not be displayed in the chart.

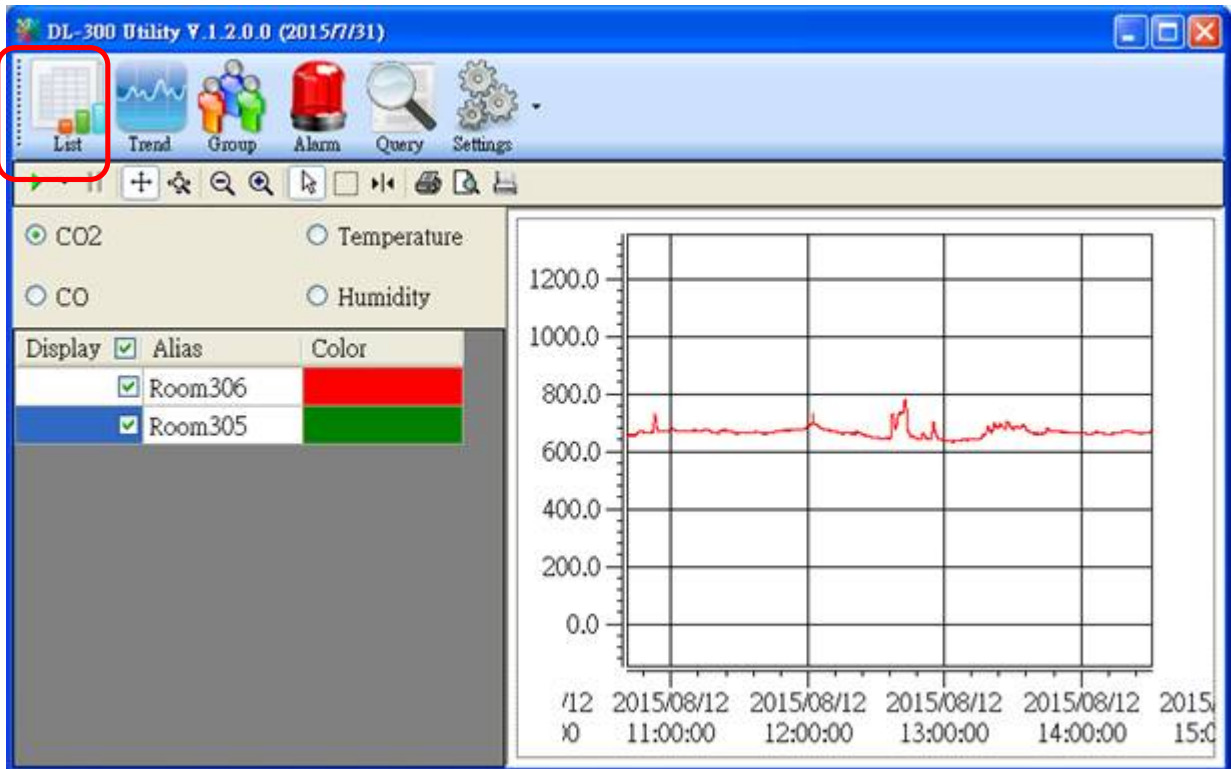

4-3. Click the **Alarm** icon to review the alarm events.

Alias	CO2	Temperature	Humidity	Dew Point	Description	Group	IP Address	Alarm
Room8A	901	25.4	62.86	17.8		1F	10.1.0.120	CO2 is over Alert Value at time:2014/11/21
Room8A	904	25.42	62.89	17.83		1F	10.1.0.120	CO2 is over Alert Value at time:2014/11/21
Room8A	899	25.33	62.86	17.74		1F	10.1.0.120	CO2 is over Alert Value at time:2014/11/21
Room8A	898	25.34	62.83	17.74		1F	10.1.0.120	CO2 is over Alert Value at time:2014/11/21
Room1A	796	27.4	56.97	18.11		1F	10.1.0.86	CO2 is over Alert Value at time:2014/11/21
Room1A	795	27.46	56.98	18.17		1F	10.1.0.86	CO2 is over Alert Value at time:2014/11/21
Room1A	792	27.44	56.98	18.15		1F	10.1.0.86	CO2 is over Alert Value at time:2014/11/21
Room1A	794	27.42	56.99	18.14		1F	10.1.0.86	CO2 is over Alert Value at time:2014/11/21
Room1A	791	27.45	56.95	18.15		1F	10.1.0.86	CO2 is over Alert Value at time:2014/11/21
Room1A	793	27.45	56.98	18.16		1F	10.1.0.86	CO2 is over Alert Value at time:2014/11/21

4-4. Modify the event condition.

Select the **System Settings** on the **Settings** menu.

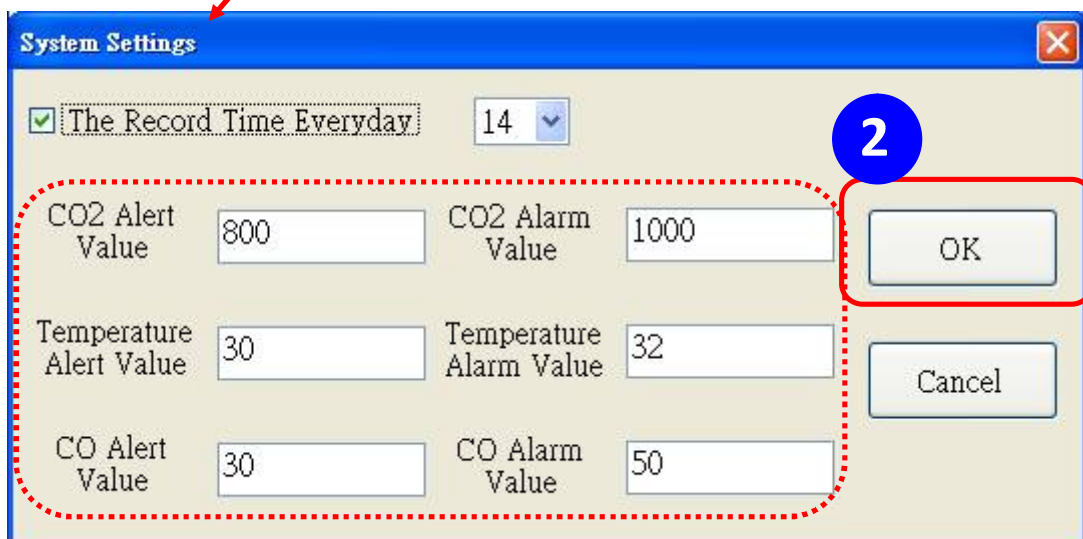
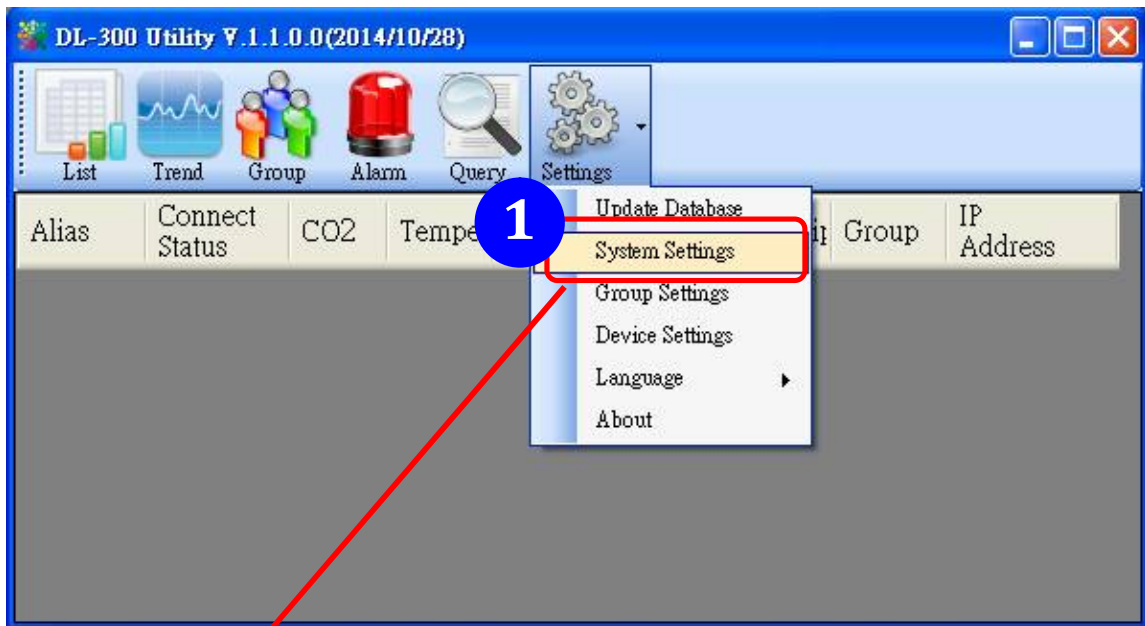

Set the *CO/CO2 Alert Value*, *CO/CO2 Alarm Value* (If it is supported in the logger), *Temperature Alert Value* and *Temperature Alarm Value* for trigger events. Check the checkbox next to *The Record Time Everyday* can schedule auto generate report everyday at the time set in the dropdown menu. Click on the **OK** button to complete the settings.

- 5. Download data in a DL-300 logger and export the data
 - 5.1. Select **Update Database** on the Settings menu
 - 5.2. Click the **Start** button to download the data in DL-100S-E modules.
 - 5.3. Click the close icon to exit the download procedure when all data are downloaded.

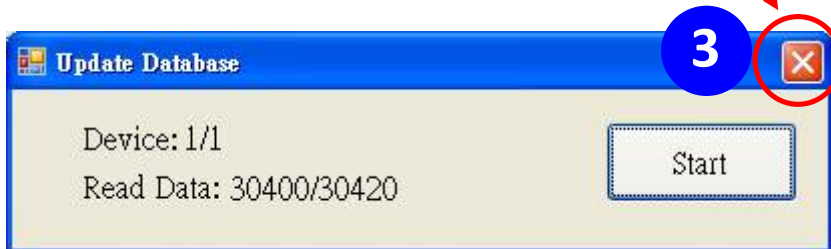
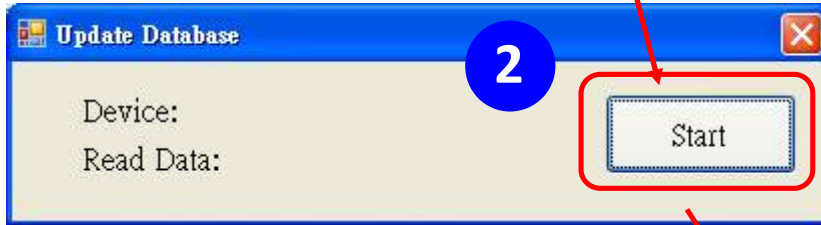
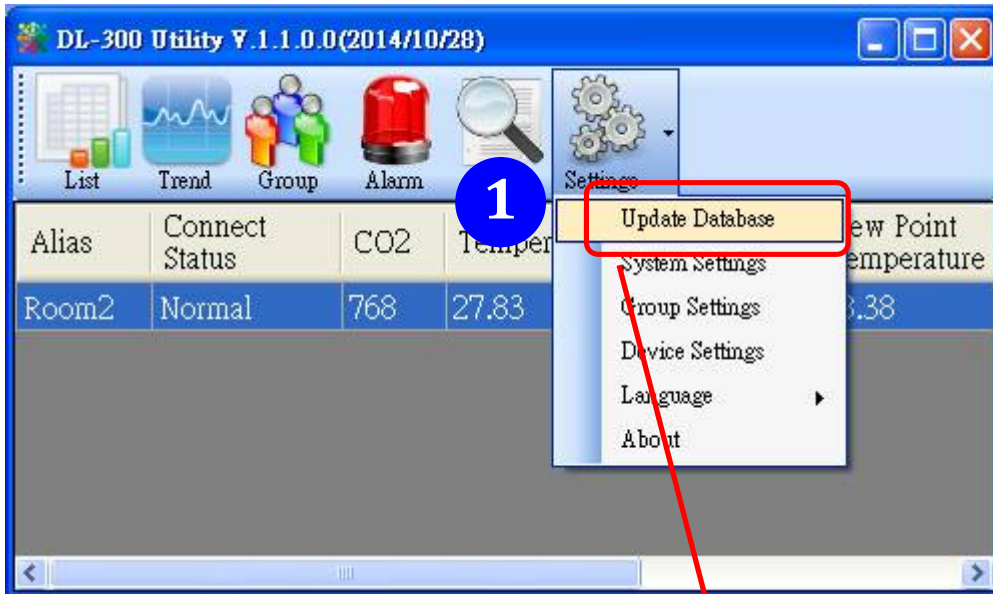

5.4. Click the **Query** icon.

5.5. Highlight the desired module, set the *Start Time* and *End Time*, and then click the **Search** button. The data in the time period will be listed as below.

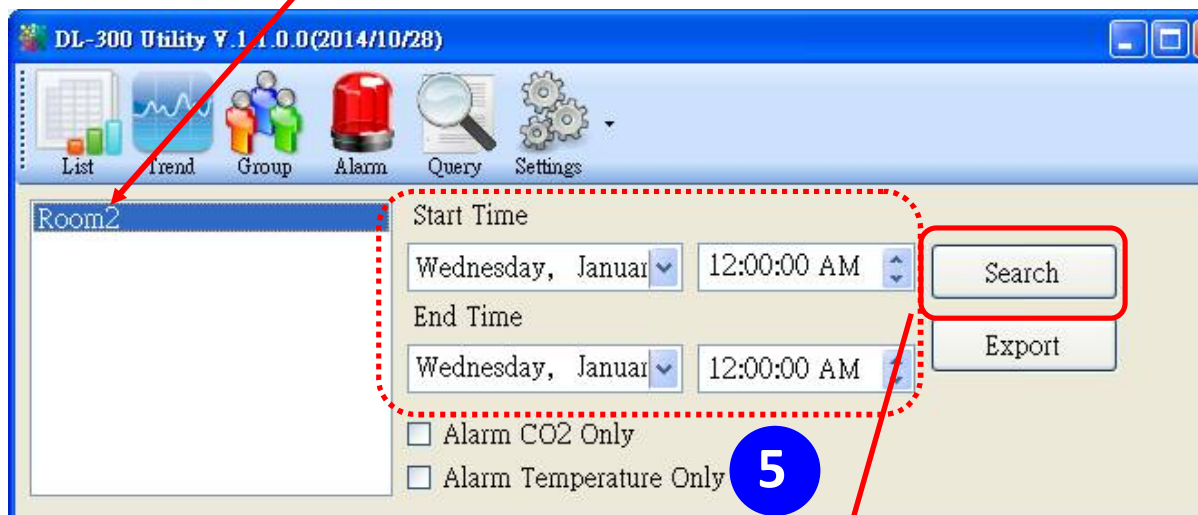

The screenshot shows the data table resulting from the query. The table has columns for Time, CO2, Humidity, Temperature, and Dew Point. The data is as follows:

Time	CO2	Humidity	Temperature	Dew Point
2014/11/25 ...	0	67.85	23.19	16.76
2014/11/25 ...	853	66.72	23.42	16.76
2014/11/25 ...	1187	67.29	23.7	17.16
2014/11/25 ...	864	65.07	23.92	16.93
2014/11/25 ...	923	64.83	24.13	17.1
2014/11/25 ...	852	64.34	24.32	17.19
2014/11/25 ...	818	63.25	24.52	17.17
2014/11/25 ...	796	62.58	24.68	17.2

5.6. Click the **Export** button to export the searched data in *.csv files for performing statistical analysis in Excel.

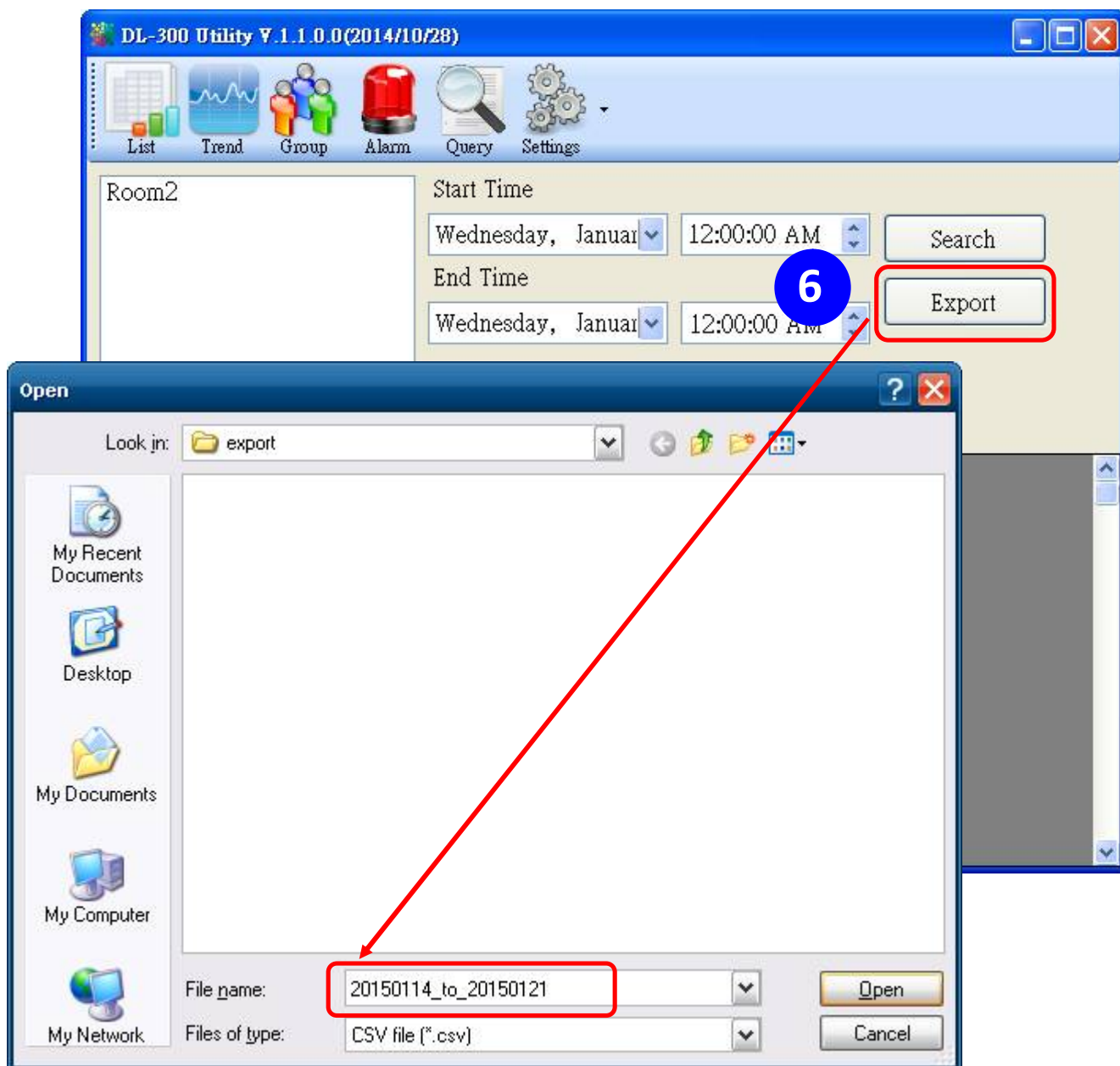

- 6. Group the devices by location or users
 - 6.1. Select **Group Settings** on the Settings menu.

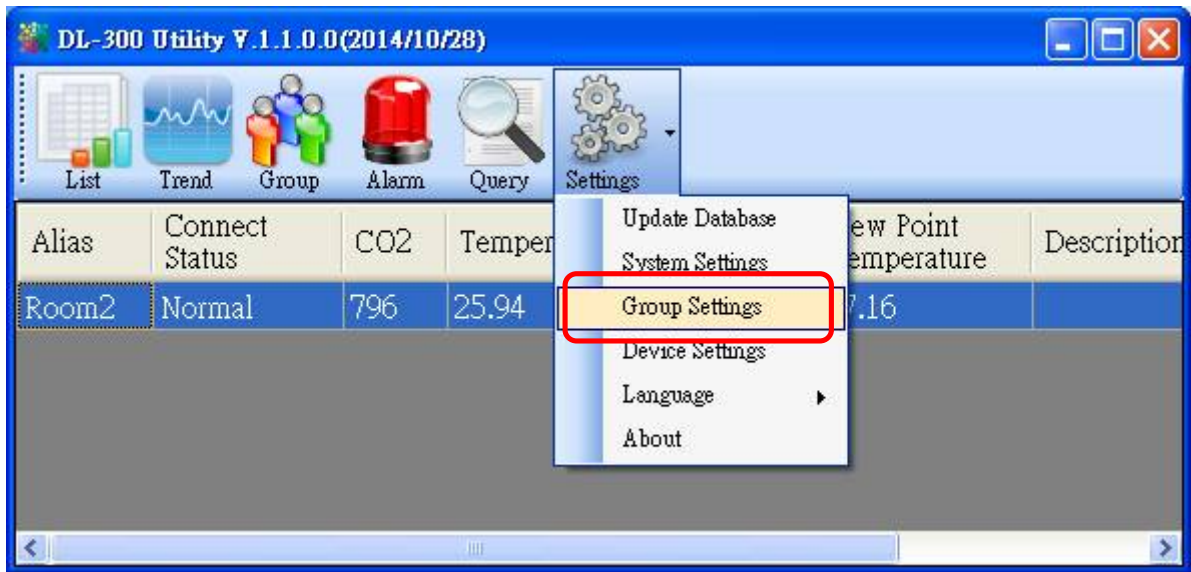

- 6.2 Click the **New** button, enter the group name and click the **OK** button in the pop-up box, and then click the **OK** button in the Group Settings box.

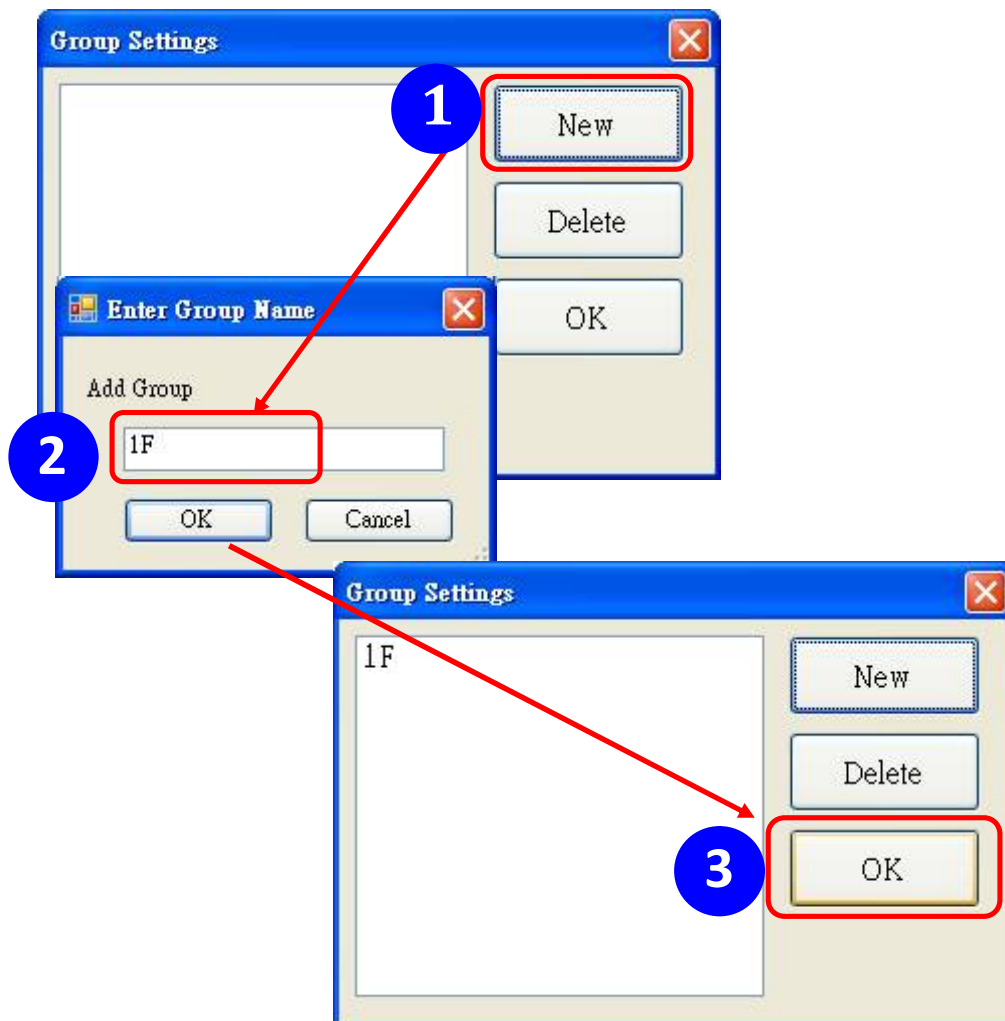

6-3. Select **Device Settings** on the **Settings** menu; highlight the desired device and click the **Edit Device** button, select the group name for the module and click the **OK** button in the pop-up **Device Property** box to complete the setting.

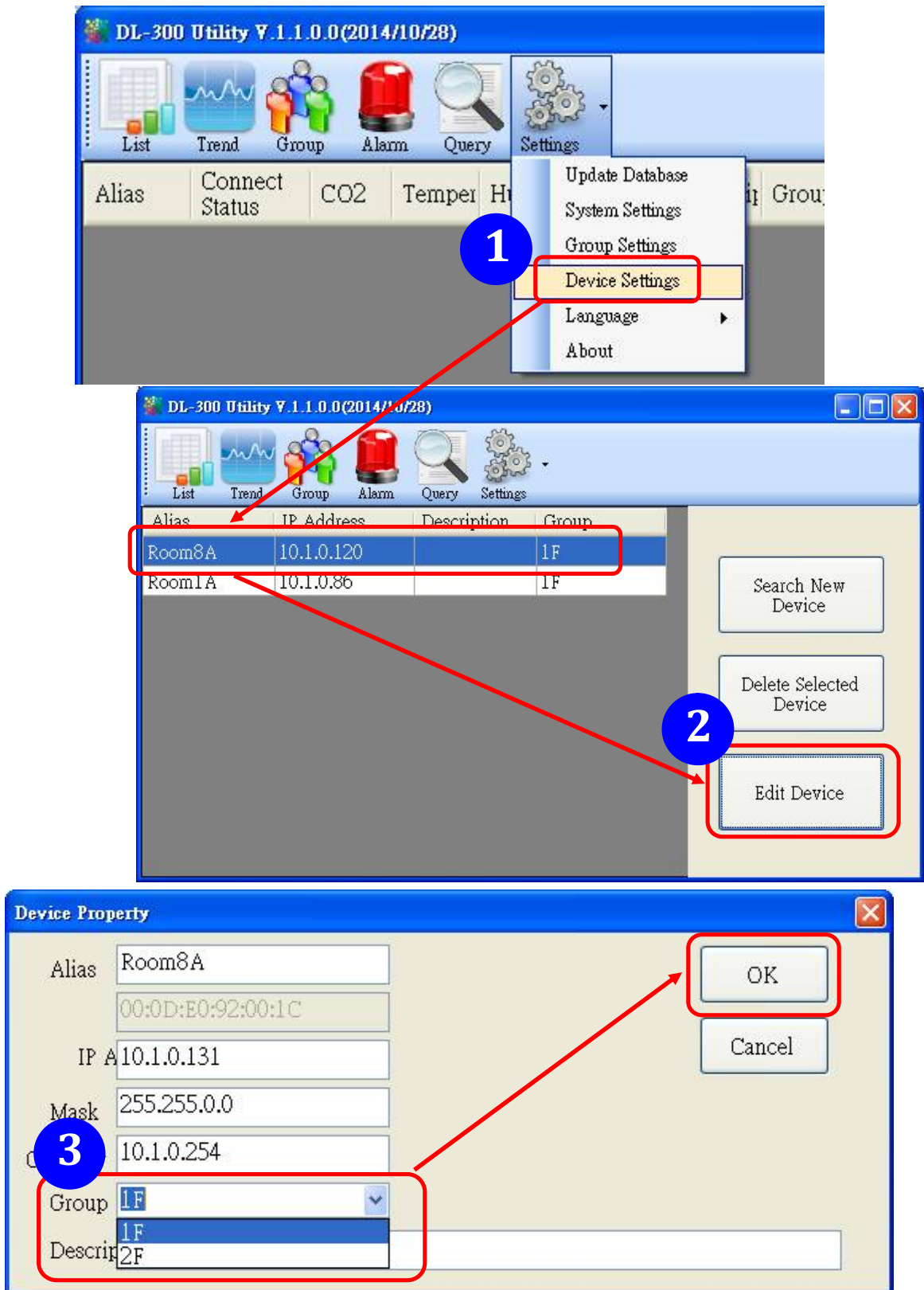

6-4. Monitor the group data by clicking the **Group** icon and then highlighting the group name.

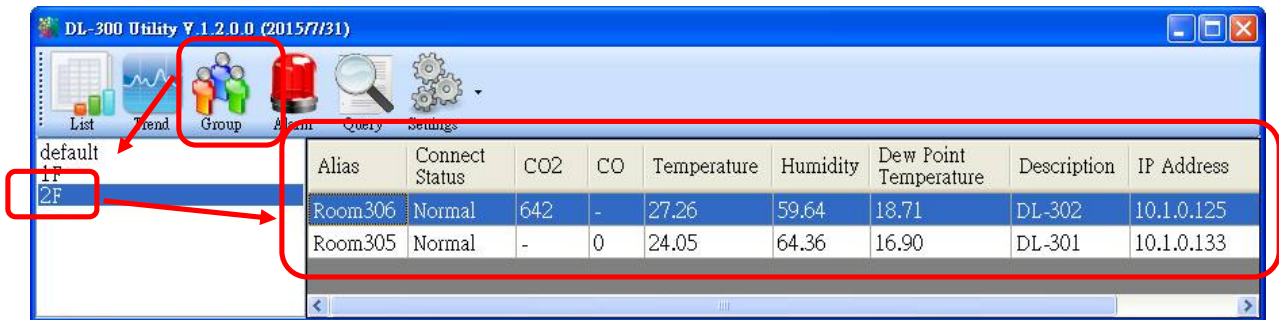

7. FAQ

Q1: How to set the Accessible IP?

A1: Enter the IP address for your logger in the address bar of a web browser and go to the *Accessible IP Settings* page, select the radio button next to *Add ____ . ____ . ____ . ____ To The List* and key in the IP for a device which is allowed to access the DL-100S-E, and then click the submit button.

Check the checkbox next to the *Save to Flash* before clicking the *submit* button to save the IP setting and use after repowering. Once any of those in the list is set, only the device for which the IP address is saved in the list can assess the DL-100S-E.

Accessible IP Settings

Accessible IP List	IP Address
IP1	0.0.0.0
IP2	0.0.0.0
IP3	0.0.0.0
IP4	0.0.0.0
IP5	0.0.0.0

Add . . . To The List
 Delete IP#
 Delete ALL
 Save to Flash

Copyright © 2014 ICP DAS Co., Ltd. All rights reserved.
10.1.0.31/filter.html

Q2: How to delete the Accessible IP settings?

A2: Enter the IP address for your logger in the address bar of a web browser and go to the *Accessible IP Settings* page, select the radio button next to *Delete IP#* to delete a IP by the IP number or select the radio button next tot *Delete All* and then click the submit button.

Check the checkbox next to the *Save to Flash* before clicking the *submit* button to save the IP setting and use after repowering.

Accessible IP Settings

Accessible IP List	IP Address
IP1	0.0.0.0
IP2	0.0.0.0
IP3	0.0.0.0
IP4	0.0.0.0
IP5	0.0.0.0

Add . . . To The List
 Delete IP#
 Delete ALL
 Save to Flash

Copyright © 2014 ICP DAS Co., Ltd. All rights reserved.
10.1.0.31/filter.html

Q3: How to clear the data logged in a DL-100S-E module?



A3: Enter the IP address for the module in the address bar of a web browser and go to the *I/O Settings* page, click the Reset Data Logger button at the bottom of the page.

Q4: How to download firmware into a DL-101S-E module?

1. Setting up the DL-101S-E

Before updating the firmware, ensure that the network settings for both your host computer and any DL-101S-E modules are correctly configured, or the update procedures via the Ethernet network may not function correctly.

Step 1: Download and Install the eSearch Utility (version is v1.1.14 or later) on your Host PC, and then run the Utility to search for DL-101S-E modules connected to the network.

Download and install the eSearch utility.

<http://ftp.icpdas.com/pub/cd/iiot/utility/esearch/>

Run the eSearch utility. Click on the Search Server button and it should find the DL-101S-E module.

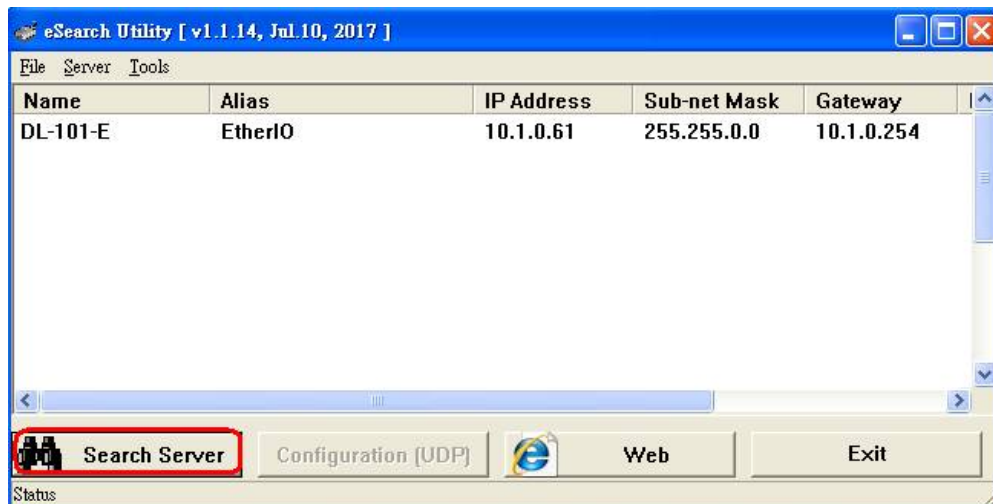

Right click on the DL-101S-E module name then select Firmware Update.

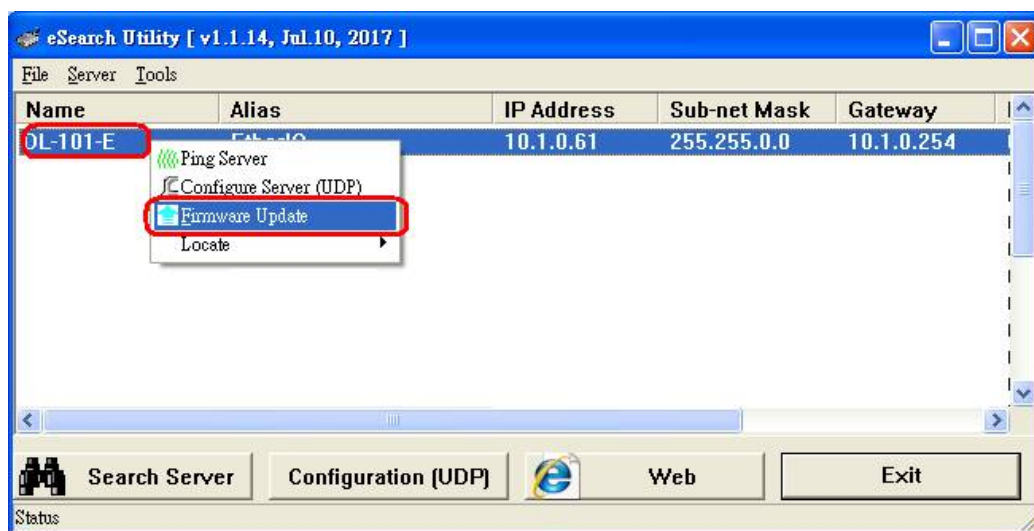

Select the firmware file and click on the Open button.



Make sure the IP address and MAC address are correct. Click on the OK button.

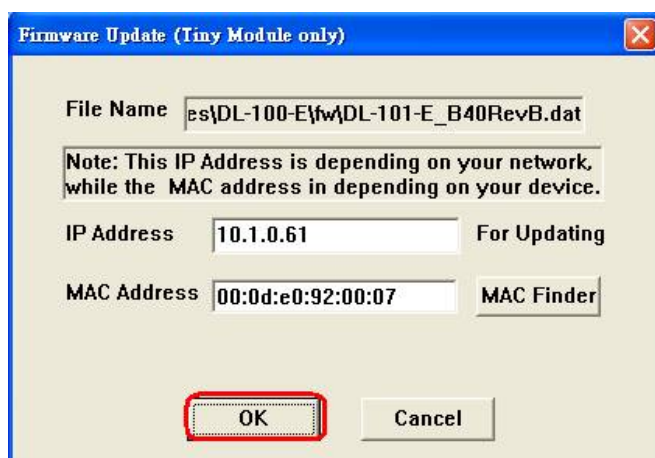

A command prompt window will be displayed to show the progress.

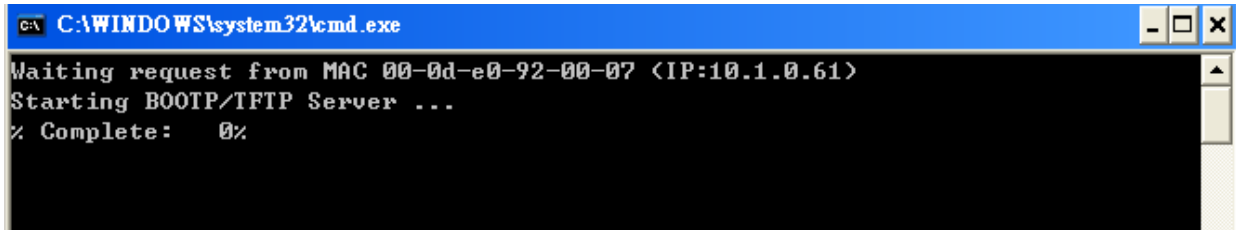

```
C:\WINDOWS\system32\cmd.exe
Waiting request from MAC 00-0d-e0-92-00-07 <IP:10.1.0.61>
Starting BOOTP/TFTP Server ...
% Complete: 0%
```

Log in the DL-101S-E web page. Click on the Network tab then click on the Update button.

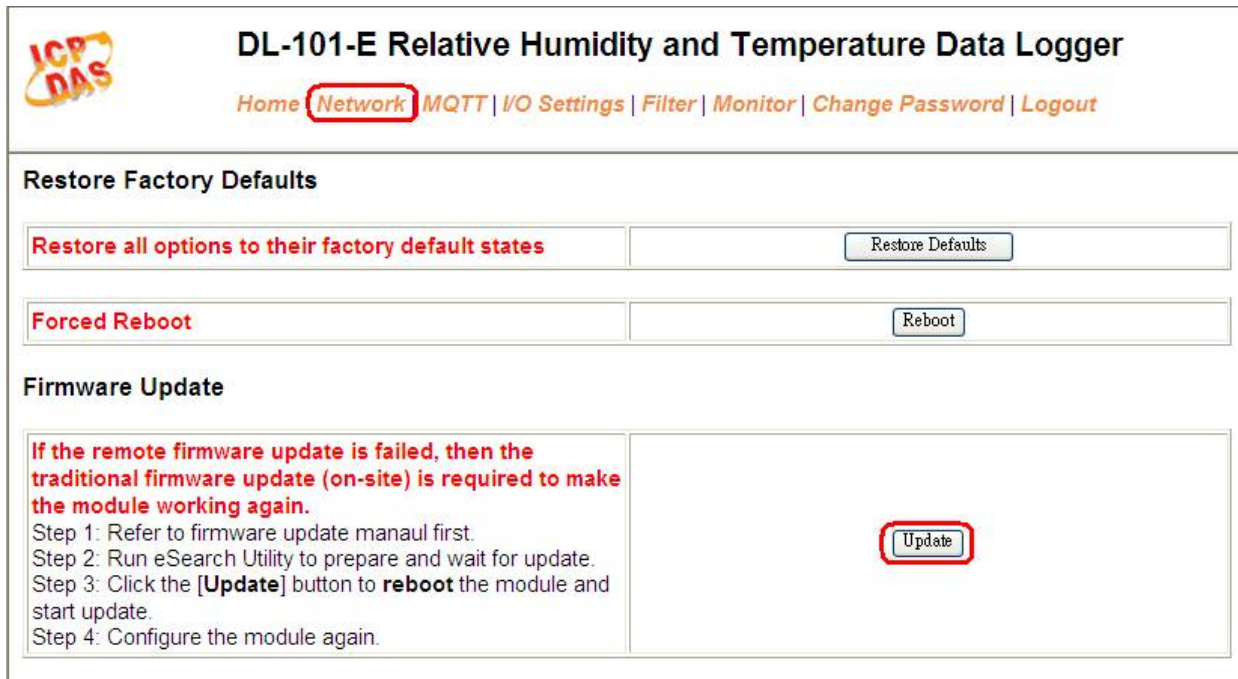

When it shows “% Complete: 100%”, the update is finished. You can close the command prompt window.

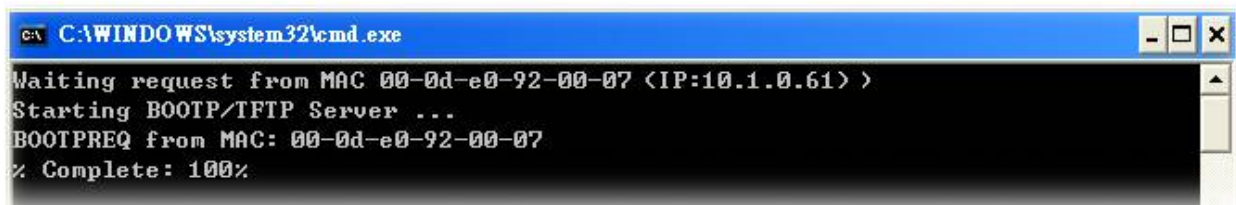

```
C:\WINDOWS\system32\cmd.exe
Waiting request from MAC 00-0d-e0-92-00-07 <IP:10.1.0.61> >
Starting BOOTP/TFTP Server ...
BOOTPREQ from MAC: 00-0d-e0-92-00-07
% Complete: 100%
```

Re-log in the DL-101S-E web page and check the firmware version.



DL-101-E Relative Humidity and Temperature Data Logger

[Home](#) | [Network](#) | [MQTT](#) | [I/O Settings](#) | [Filter](#) | [Monitor](#) | [Change Password](#) | [Logout](#)

Status & Configuration

Model Name	DL-101-E	Alias Name	EtherIO
Firmware Version	B4.0 [Dec. 5, 2017]	MAC Address	00-0D-E0-92-00-07
IP Address	10.1.0.61	TCP Port Timeout (Socket Watchdog, Seconds)	180
Initial Switch	OFF	System Timeout (Network Watchdog, Seconds)	0

Appendix A: ModbusMasterToolPC

ModbusMasterToolPC is a free, easy-to-use tool for Modbus communication and diagnosing the wiring.

Download and install the ModbusMasterToolPC

<http://ftp.icpdas.com/pub/cd/iiot/utility/modbusmastertoolpc/>

This section intends to guide the steps for creating the Modbus communication with DL-100S-E logger.

1. Launch the ModbusMasterToolPC.exe.
2. Select **New** in the File menu.

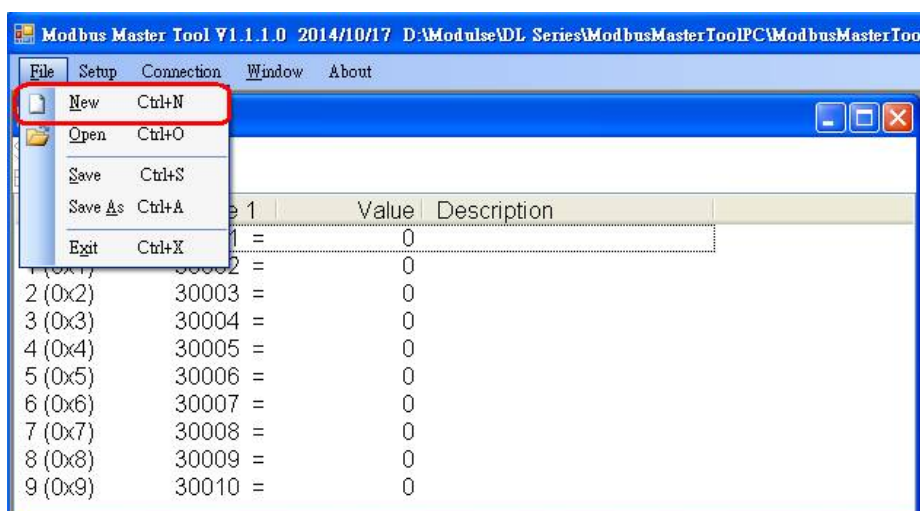

3. Input the file name and click on the **Save** button.

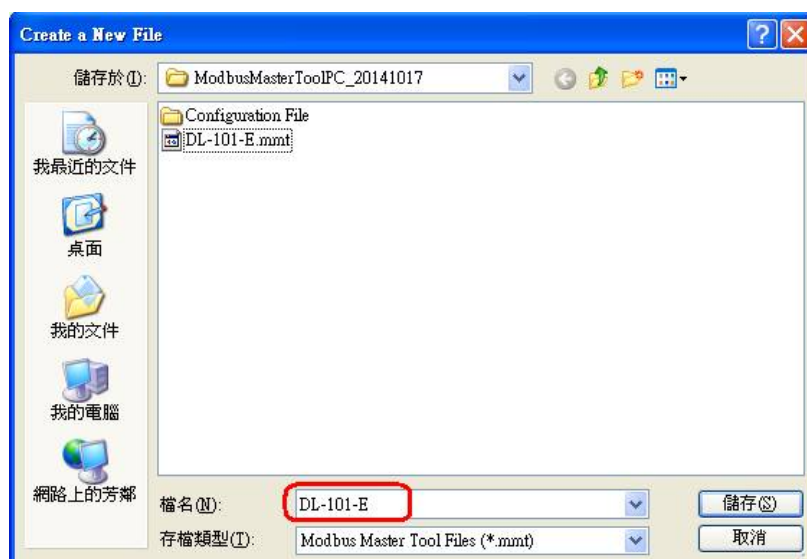

4. Select **Connect** in the *Connection* menu.

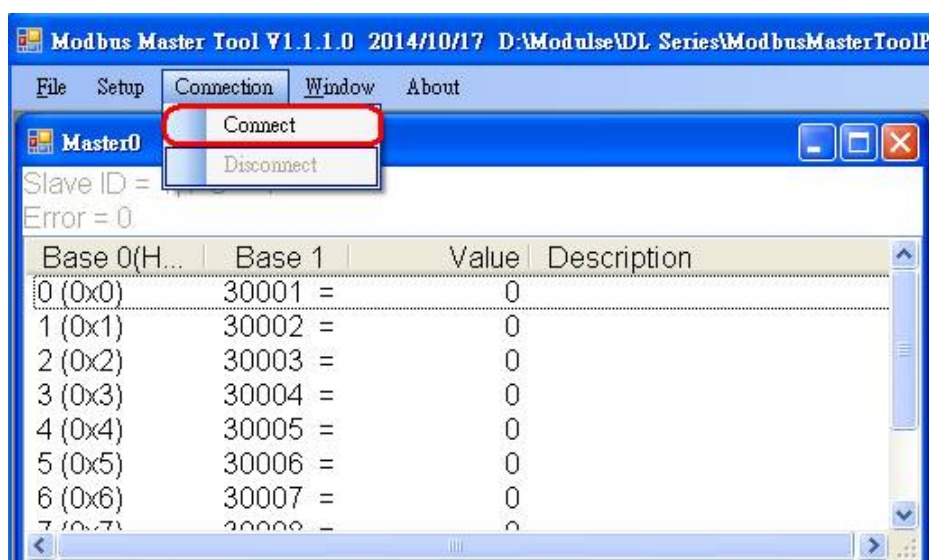

5. Select the communication interface. When using **TCP/IP** as the interface, input the IP for your logger and click on the **OK** button.

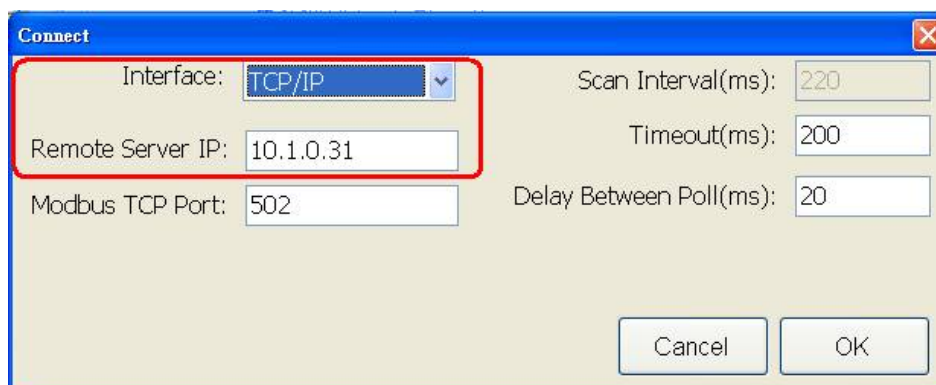

6. Select **Definition** in the *Setup* menu.

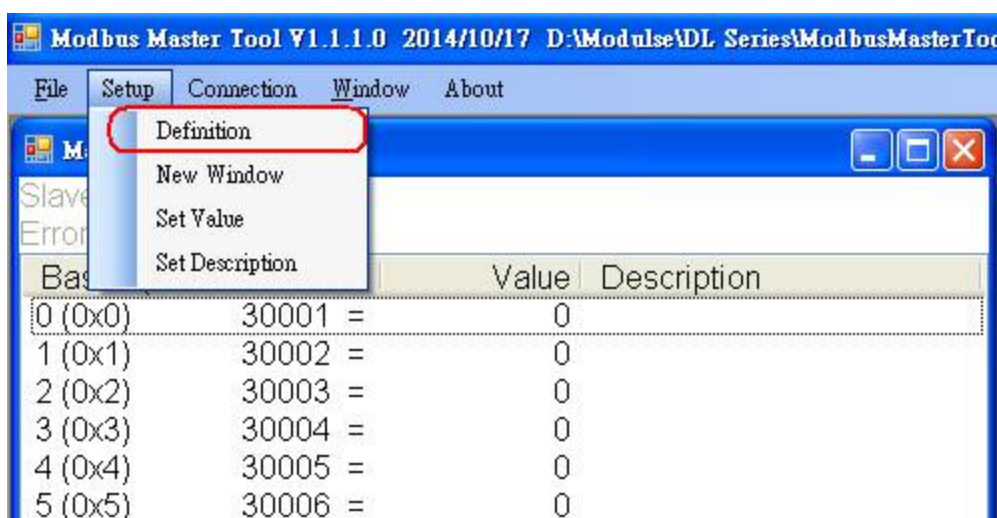

7. Select the Modbus Function code, input the start address and length, and click on the **OK** button.

The 'Definition' dialog box contains the following fields and controls:

- Slave ID:
- Function: (dropdown menu)
- Address:
- Length:
- Format: (dropdown menu)
- Descriptions: Clear All Descriptions
- Buttons: OK, Cancel

8. Read data.

The 'Master0' window displays the following data:

Slave ID = 1, FC = 4
Error = 0

Base 0(H...	Base 1	Value	Description
0 (0x0)	30001 =	6185	
1 (0x1)	30002 =	2554	
2 (0x2)	30003 =	7797	
3 (0x3)	30004 =	1768	
4 (0x4)	30005 =	6382	
5 (0x5)	30006 =	0	
6 (0x6)	30007 =	0	
7 (0x7)	30008 =	0	
8 (0x8)	30009 =	0	
9 (0x9)	30010 =	0	

Appendix B: Modbus Address Table

B-1. DL-100S-E Modbus Address Mappings (Base 1)

Address	Description	Attribute
30001 ~ 30005 40001 ~ 40005	Analog input value of channel 0 to 4. channel 0: relative humidity in 0.01%, channel 1: temperature in 0.01°C, channel 2: temperature in 0.01°F, channel 3: dew point temperature in 0.01°C, channel 4: dew point temperature in 0.01°F	R
40181 ~ 40196	Module alias name	R
40272	Modbus NetID	R/W
30301 40301	Number of the digital input channels	R
30311 40311	Number of the digital output channels	R
30321 40321	Number of the analog input channels	R
30331 40331	Number of the analog output channels	R
30352 40352	Firmware version in hex format	R
40449	Relative humidity offset in 0.01%	R/W
40450	Temperature offset in 0.01°C	R/W
40481	Firmware version (low word)	R
40482	Firmware version (high word)	R
40483	Module name (low word), 0x0101	R
40484	Module name (high word), 0x444C	R
30513 ~ 30517 40513 ~ 40517	High latched analog input value of channel 0 to 4	R
30545 ~ 30549 40545 ~ 40549	Low latched analog input value of channel 0 to 4	R
30556 40556	Module reset status, 1: power-on, 2: watchdog, 3: software reset command	R
40558	Ethernet host watchdog timeout value, 5 to 65535, in second, 0 to disable.	R/W

Address	Description	Attribute
30559 40559	Ethernet host watchdog timeout count.	R
30560 40560	Module name, 0x0101	R
40564	TCP disconnection timeout value, 5 to 65535, in second, 0 to disable.	R/W
40565	Module reset timeout value, 30 to 65535, in second, 0 to disable.	R/W
40801	Number of seconds in a cycle to display temperature in Celsius on LCD, 0 ~ 100	R/W
40802	Number of seconds in a cycle to display temperature in Fahrenheit on LCD, 0 ~ 100	R/W
40803	Number of seconds in a cycle to display relative humidity on LCD, 0 ~ 100	R/W
40804	Number of seconds in a cycle to display date on LCD, 0 ~ 100	R/W
40805	Number of seconds in a cycle to display time on LCD, 0 ~ 100	R/W
40865	RTC year, 2000 to 2159	R/W
40866	RTC month, 1 to 12	R/W
40867	RTC date, 1 to 31	R/W
40868	RTC hour, 0 to 23	R/W
40869	RTC minute, 0 to 59	R/W
40870	RTC second, 0 to 59	R/W
40871	Total number of log records, low word	R
40872	Total number of log records, high word	R
40873	The starting record to read log data, low word	R/W
40874	The starting record to read log data, high word	R/W
40875	The status of the data logging, 0: stopped, 1: running	R
40876	The data logger command, 0: stop, 1: run, 2: run in period mode	R/W
40877	Continue writing when data logger is full, 0: no, 1: yes	R/W
40878	Hour of the data logger sampling period, 0 ~ 24	R/W
40879	Minute of the data logger sampling period, 0 ~ 59	R/W
40880	Second of the data logger sampling period, 0 ~ 59	R/W

Address	Description	Attribute
40881	Starting year when logging in period mode, 2000 ~ 2159	R/W
40882	Starting month when logging in period mode, 1 ~ 12	R/W
40883	Starting date when logging in period mode, 1 ~ 31	R/W
40884	Starting hour when logging in period mode, 0 ~ 23	R/W
40885	Starting minute when logging in period mode, 0 ~ 59	R/W
40886	Starting second when logging in period mode, 0 ~ 59	R/W
40887	Ending year when logging in period mode, 2000 ~ 2159	R/W
40888	Ending month when logging in period mode, 1 ~ 12	R/W
40889	Ending date when logging in period mode, 1 ~ 31	R/W
40890	Ending hour when logging in period mode, 0 ~ 23	R/W
40891	Ending minute when logging in period mode, 0 ~ 59	R/W
40892	Ending second when logging in period mode, 0 ~ 59	R/W
00227	Write 1 to reload default TCP settings and reboot module	W
00234	Write 1 to reboot module	W
00280	Write 1 to clear all high latched analog input values	W
00281	Write 1 to clear all low latched analog input values	W
00385 ~ 00389	Write 1 to clear high latched analog input value of channel 0 to 4	W
00417 ~ 00421	Write 1 to clear low latched analog input value of channel 0 to 4	W

B-2. DL-101S-E Modbus Address Mappings (Base 1)

Address	Description	Attribute
30001 ~ 30005 40001 ~ 40005	Analog input value of channel 0 to 4. channel 0: relative humidity in 0.01%, channel 1: temperature in 0.01°C, channel 2: temperature in 0.01°F, channel 3: dew point temperature in 0.01°C, channel 4: dew point temperature in 0.01°F	R
40181 ~ 40196	Module alias name	R
40225 ~ 40229	High alarm limit of channel 0 to 4, channel 0: relative humidity in 0.01%, channel 1: temperature in 0.01°C, channel 2: temperature in 0.01°F, channel 3: dew point temperature in 0.01°C, channel 4: dew point temperature in 0.01°F	R/W
40233 ~ 40237	Low alarm limit of channel 0 to 4, channel 0: relative humidity in 0.01%, channel 1: temperature in 0.01°C, channel 2: temperature in 0.01°F, channel 3: dew point temperature in 0.01°C, channel 4: dew point temperature in 0.01°F	R/W
40272	Modbus NetID	R/W
30301 40301	Number of the digital input channels	R
30311 40311	Number of the digital output channels	R
30321 40321	Number of the analog input channels	R
30331 40331	Number of the analog output channels	R
30352 40352	Firmware version in hex format	R
40449	Relative humidity offset in 0.01%	R/W
40450	Temperature offset in 0.01°C	R/W
40481	Firmware version (low word)	R
40482	Firmware version (high word)	R
40483	Module name (low word), 0x0100	R
40484	Module name (high word), 0x444C	R

Address	Description	Attribute
30513 ~ 30517 40513 ~ 40517	High latched analog input value of channel 0 to 4	R
30545 ~ 30549 40545 ~ 40549	Low latched analog input value of channel 0 to 4	R
30556 40556	Module reset status, 1: power-on, 2: watchdog, 3: software reset command	R
40558	Ethernet host watchdog timeout value, 5 to 65535, in second, 0 to disable.	R/W
30559 40559	Ethernet host watchdog timeout count.	R
30560 40560	Module name, 0x0100	R
40564	TCP disconnection timeout value, 5 to 65535, in second, 0 to disable.	R/W
40565	Module reset timeout value, 30 to 65535, in second, 0 to disable.	R/W
40801	Number of seconds in a cycle to display temperature in Celsius on LCD, 0 ~ 100	R/W
40802	Number of seconds in a cycle to display temperature in Fahrenheit on LCD, 0 ~ 100	R/W
40803	Number of seconds in a cycle to display relative humidity on LCD, 0 ~ 100	R/W
40804	Number of seconds in a cycle to display date on LCD, 0 ~ 100	R/W
40805	Number of seconds in a cycle to display time on LCD, 0 ~ 100	R/W
40865	RTC year, 2000 to 2159	R/W
40866	RTC month, 1 to 12	R/W
40867	RTC date, 1 to 31	R/W
40868	RTC hour, 0 to 23	R/W
40869	RTC minute, 0 to 59	R/W
40870	RTC second, 0 to 59	R/W
40871	Total number of log records, low word	R
40872	Total number of log records, high word	R

Address	Description	Attribute
40873	The starting record to read log data, low word	R/W
40874	The starting record to read log data, high word	R/W
40875	The status of the data logging, 0: stopped, 1: running	R
40876	The data logger command, 0: stop, 1: run, 2: run in period mode	R/W
40877	Continue writing when data logger is full, 0: no, 1: yes	R/W
40878	Hour of the data logger sampling period, 0 ~ 24	R/W
40879	Minute of the data logger sampling period, 0 ~ 59	R/W
40880	Second of the data logger sampling period, 0 ~ 59	R/W
40881	Starting year when logging in period mode, 2000 ~ 2159	R/W
40882	Starting month when logging in period mode, 1 ~ 12	R/W
40883	Starting date when logging in period mode, 1 ~ 31	R/W
40884	Starting hour when logging in period mode, 0 ~ 23	R/W
40885	Starting minute when logging in period mode, 0 ~ 59	R/W
40886	Starting second when logging in period mode, 0 ~ 59	R/W
40887	Ending year when logging in period mode, 2000 ~ 2159	R/W
40888	Ending month when logging in period mode, 1 ~ 12	R/W
40889	Ending date when logging in period mode, 1 ~ 31	R/W
40890	Ending hour when logging in period mode, 0 ~ 23	R/W
40891	Ending minute when logging in period mode, 0 ~ 59	R/W
40892	Ending second when logging in period mode, 0 ~ 59	R/W

Address	Description	Attribute
00001 ~ 00002	Digital output value of channel 0 to 1 If relative humidity alarm is enabled, then the digital output of channel 0 is used as its alarm. If temperature alarm or dew point alarm are enabled, then the digital output of channel 2 is used as their alarm.	R/W
00129 ~ 00130	Safe value of digital output channel 0 to 1	R/W
00161 ~ 00162	Power on value of digital output channel 0 to 1	R/W
00227	Write 1 to reload default TCP settings and reboot module	W
00234	Write 1 to reboot module	W
00280	Write 1 to clear all high latched analog input values	W
00281	Write 1 to clear all low latched analog input values	W
00289 ~ 00293	Low alarm status of channel 0 to 4. Write 1 to clear low latched alarm.	R/W
00305 ~ 00309	High alarm status of channel 0 to 4. Write 1 to clear high latched alarm.	R/W
00321 ~ 00325	Enable/disable alarm of channel 0 to 4	R/W
00337 ~ 00341	Alarm type, momentary or latched, of channel 0 to 4	R/W
00385 ~ 00389	Write 1 to clear high latched analog input value of channel 0 to 4	W
00417 ~ 00421	Write 1 to clear low latched analog input value of channel 0 to 4	W

B-3. DL-110-E Modbus Address Mappings (Base 1)

Address	Description	Attribute
30001 ~ 30007 40001 ~ 40007	Analog input value of channel 0 to 6. channel 0: relative humidity in 0.01%, channel 1: temperature in 0.01°C, channel 2: temperature in 0.01°F, channel 3: dew point temperature in 0.01°C, channel 4: dew point temperature in 0.01°F, channel 5: low word of ambient light in lux, channel 6: high word of ambient light in lux	R
40181 ~ 40196	Module alias name	R
40272	Modbus NetID Only for Modbus TCP protocol	R/W
30301 40301	Number of the digital input channels Only for Modbus TCP protocol	R
30311 40311	Number of the digital output channels Only for Modbus TCP protocol	R
30321 40321	Number of the analog input channels Only for Modbus TCP protocol	R
30331 40331	Number of the analog output channels Only for Modbus TCP protocol	R
30352 40352	Firmware version in hex format Only for Modbus TCP protocol	R
40449	Relative humidity offset in 0.01%	R/W
40450	Temperature offset in 0.01°C	R/W
40454	Ambient light offset in lux	R/W
40481	Firmware version (low word)	R
40482	Firmware version (high word)	R
40483	Module name (low word), 0x0100	R
40484	Module name (high word), 0x444C	R
40485	RS-485 module address, 1 to 247 Only for Modbus RTU protocol	R/W

Address	Description	Attribute
40486	RS-485 baud rate and parity settings Bits 5:0 Baud rate, valid range: 3 ~ 10 Bits 7:6 00: no parity, 1 stop bit 01: no parity, 2 stop bit 10: even parity, 1 stop bit 11: odd parity , 1 stop bit Only for Modbus RTU protocol	R/W
40488	RS-485 response delay time in ms, valid range, 0 ~ 30 Only for Modbus RTU protocol	R/W
40489	RS-485 host watchdog timeout value, 0 ~ 255, in 0.1s Only for Modbus RTU protocol	R/W
40492	RS-485 host watchdog timeout count, write 0 to clear Only for Modbus RTU protocol	R/W
30513 ~ 30519 40513 ~ 40519	High latched analog input value of channel 0 to 6	R
30545 ~ 30551 40545 ~ 40551	Low latched analog input value of channel 0 to 6	R
30556 40556	Module reset status, 1: power-on, 2: watchdog, 3: software reset command Only for Modbus TCP protocol	R
40558	Ethernet host watchdog timeout value, 5 to 65535, in second, 0 to disable. Only for Modbus TCP protocol	R/W
30559 40559	Ethernet host watchdog timeout count. Only for Modbus TCP protocol	R
30560 40560	Module name, 0x0110 Only for Modbus TCP protocol	R

Address	Description	Attribute
40564	TCP disconnection timeout value, 5 to 65535, in second, 0 to disable. Only for Modbus TCP protocol	R/W
40565	Module reset timeout value, 30 to 65535, in second, 0 to disable. Only for Modbus TCP protocol	R/W
40865	RTC year, 2000 to 2159	R/W
40866	RTC month, 1 to 12	R/W
40867	RTC date, 1 to 31	R/W
40868	RTC hour, 0 to 23	R/W
40869	RTC minute, 0 to 59	R/W
40870	RTC second, 0 to 59	R/W
40871	Total number of log records, low word	R
40872	Total number of log records, high word	R
40873	The starting record to read log data, low word	R/W
40874	The starting record to read log data, high word	R/W
40875	The status of the data logging, 0: stopped, 1: running	R
40876	The data logger command, 0: stop, 1: run, 2: run in period mode	R/W
40877	Continue writing when data logger is full, 0: no, 1: yes	R/W
40878	Hour of the data logger sampling period, 0 ~ 24	R/W
40879	Minute of the data logger sampling period, 0 ~ 59	R/W
40880	Second of the data logger sampling period, 0 ~ 59	R/W
40881	Starting year when logging in period mode, 2000 ~ 2159	R/W
40882	Starting month when logging in period mode, 1 ~ 12	R/W
40883	Starting date when logging in period mode, 1 ~ 31	R/W
40884	Starting hour when logging in period mode, 0 ~ 23	R/W
40885	Starting minute when logging in period mode, 0 ~ 59	R/W

Address	Description	Attribute
40886	Starting second when logging in period mode, 0 ~ 59	R/W
40887	Ending year when logging in period mode, 2000 ~ 2159	R/W
40888	Ending month when logging in period mode, 1 ~ 12	R/W
40889	Ending date when logging in period mode, 1 ~ 31	R/W
40890	Ending hour when logging in period mode, 0 ~ 23	R/W
40891	Ending minute when logging in period mode, 0 ~ 59	R/W
40892	Ending second when logging in period mode, 0 ~ 59	R/W
00227	Write 1 to reload default TCP settings and reboot module Only for Modbus TCP protocol	W
00234	Write 1 to reboot module Only for Modbus TCP protocol	W
00257	RS-485 Protocol, 0: DCON, 1: Modbus RTU Only for Modbus RTU protocol	R/W
00261	RS-485 host watchdog mode, 1: enable, 0: disable. Only for Modbus RTU protocol	R/W
00270	Host watch dog timeout status, write 1 to clear host watch dog timeout status Only for Modbus RTU protocol	R/W
00273	Reset status, 1: first read after powered on, 0: not the first read after powered on Only for Modbus RTU protocol	R
00280	Write 1 to clear all high latched analog input values	W
00281	Write 1 to clear all low latched analog input values	W
00385 ~ 00391	Write 1 to clear high latched analog input value of channel 0 to 6	W
00417 ~ 00423	Write 1 to clear low latched analog input value of channel 0 to 6	W

B-4. DL-120-E Modbus Address Mappings (Base 1)

Address	Description	Attribute
30001 ~ 30002 40001 ~ 40002	Analog input value of channel 0 to 1. channel 0: low word of ambient light in lux, channel 1: high word of ambient light in lux	R
40181 ~ 40196	Module alias name	R
40272	Modbus NetID Only for Modbus TCP protocol	R/W
30301 40301	Number of the digital input channels Only for Modbus TCP protocol	R
30311 40311	Number of the digital output channels Only for Modbus TCP protocol	R
30321 40321	Number of the analog input channels Only for Modbus TCP protocol	R
30331 40331	Number of the analog output channels Only for Modbus TCP protocol	R
30352 40352	Firmware version in hex format Only for Modbus TCP protocol	R
40449	Ambient light offset in lux	R/W
40481	Firmware version (low word)	R
40482	Firmware version (high word)	R
40483	Module name (low word), 0x0100	R
40484	Module name (high word), 0x444C	R
40485	RS-485 module address, 1 to 247 Only for Modbus RTU protocol	R/W
40486	RS-485 baud rate and parity settings Bits 5:0 Baud rate, valid range: 3 ~ 10 Bits 7:6 00: no parity, 1 stop bit 01: no parity, 2 stop bit 10: even parity, 1 stop bit 11: odd parity , 1 stop bit Only for Modbus RTU protocol	R/W

Address	Description	Attribute
40488	RS-485 response delay time in ms, valid range, 0 ~ 30 Only for Modbus RTU protocol	R/W
40489	RS-485 host watchdog timeout value, 0 ~ 255, in 0.1s Only for Modbus RTU protocol	R/W
40492	RS-485 host watchdog timeout count, write 0 to clear Only for Modbus RTU protocol	R/W
30513 ~ 30514 40513 ~ 40514	High latched analog input value of channel 0 to 1	R
30545 ~ 30546 40545 ~ 40546	Low latched analog input value of channel 0 to 1	R
30556 40556	Module reset status, 1: power-on, 2: watchdog, 3: software reset command Only for Modbus TCP protocol	R
40558	Ethernet host watchdog timeout value, 5 to 65535, in second, 0 to disable. Only for Modbus TCP protocol	R/W
30559 40559	Ethernet host watchdog timeout count. Only for Modbus TCP protocol	R
30560 40560	Module name, 0x0120 Only for Modbus TCP protocol	R
40564	TCP disconnection timeout value, 5 to 65535, in second, 0 to disable. Only for Modbus TCP protocol	R/W
40565	Module reset timeout value, 30 to 65535, in second, 0 to disable. Only for Modbus TCP protocol	R/W
40865	RTC year, 2000 to 2159	R/W
40866	RTC month, 1 to 12	R/W
40867	RTC date, 1 to 31	R/W

Address	Description	Attribute
40869	RTC minute, 0 to 59	R/W
40870	RTC second, 0 to 59	R/W
40871	Total number of log records, low word	R
40872	Total number of log records, high word	R
40873	The starting record to read log data, low word	R/W
40874	The starting record to read log data, high word	R/W
40875	The status of the data logging, 0: stopped, 1: running	R
40876	The data logger command, 0: stop, 1: run, 2: run in period mode	R/W
40877	Continue writing when data logger is full, 0: no, 1: yes	R/W
40878	Hour of the data logger sampling period, 0 ~ 24	R/W
40879	Minute of the data logger sampling period, 0 ~ 59	R/W
40880	Second of the data logger sampling period, 0 ~ 59	R/W
40881	Starting year when logging in period mode, 2000 ~ 2159	R/W
40882	Starting month when logging in period mode, 1 ~ 12	R/W
40883	Starting date when logging in period mode, 1 ~ 31	R/W
40884	Starting hour when logging in period mode, 0 ~ 23	R/W
40885	Starting minute when logging in period mode, 0 ~ 59	R/W
40886	Starting second when logging in period mode, 0 ~ 59	R/W
40887	Ending year when logging in period mode, 2000 ~ 2159	R/W
40888	Ending month when logging in period mode, 1 ~ 12	R/W
40889	Ending date when logging in period mode, 1 ~ 31	R/W
40890	Ending hour when logging in period mode, 0 ~ 23	R/W
40891	Ending minute when logging in period mode, 0 ~ 59	R/W
40892	Ending second when logging in period mode, 0 ~ 59	R/W

Address	Description	Attribute
00227	Write 1 to reload default TCP settings and reboot module Only for Modbus TCP protocol	W
00234	Write 1 to reboot module Only for Modbus TCP protocol	W
00257	RS-485 Protocol, 0: DCON, 1: Modbus RTU Only for Modbus RTU protocol	R/W
00261	RS-485 host watchdog mode, 1: enable, 0: disable. Only for Modbus RTU protocol	R/W
00270	Host watch dog timeout status, write 1 to clear host watch dog timeout status Only for Modbus RTU protocol	R/W
00273	Reset status, 1: first read after powered on, 0: not the first read after powered on Only for Modbus RTU protocol	R
00280	Write 1 to clear all high latched analog input values	W
00281	Write 1 to clear all low latched analog input values	W
00385 ~ 00386	Write 1 to clear high latched analog input value of channel 0 to 1	W
00417 ~ 00418	Write 1 to clear low latched analog input value of channel 0 to 1	W

Revision History

Revision	Date	Description
1.0.0	2020/May	First released